



H Husqvarna®



550iBTX

Contents

Introduction.....	2	Transportation, storage and disposal.....	18
Safety.....	4	Technical data.....	18
Assembly.....	13	Accessories.....	20
Operation.....	15	EC Declaration of Conformity.....	21
Maintenance.....	17	Registered trademarks.....	21
Troubleshooting.....	18		

Introduction

Product overview

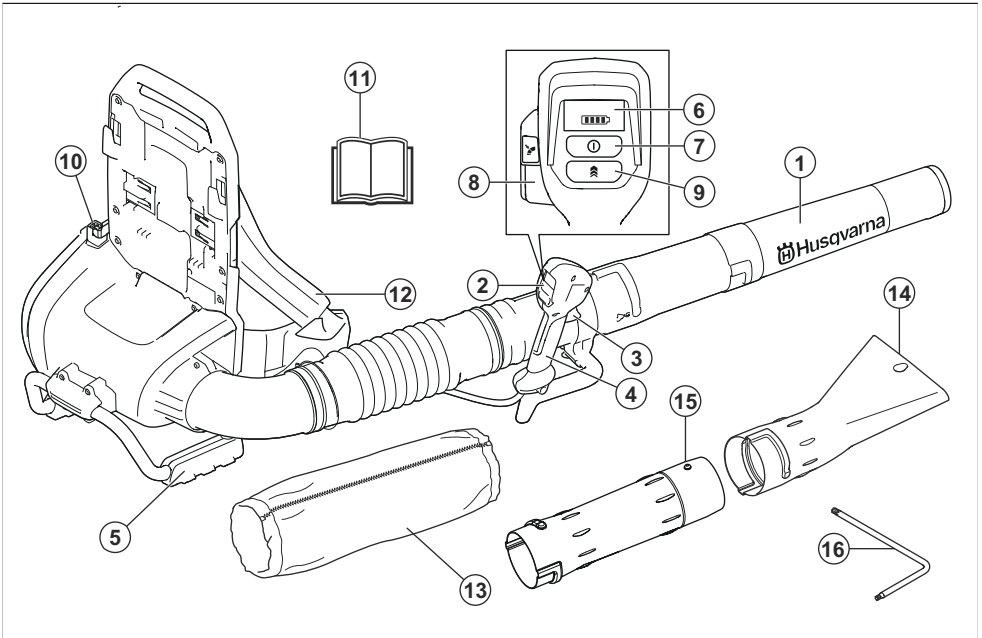

1. Blower nozzle
2. Keypad
3. Power trigger
4. Handle
5. Support
6. Keypad display
7. On/Off button
8. Cruise control: Set the optimal air flow for your work
9. Boost mode: Increase of airflow
10. Battery connector
11. Operator's manual
12. Backpack harness
13. Sleeve

14. Flat nozzle
15. Intermediate pipe
16. Hex key

Product description

The product is a battery backpack blower with an electrical motor.

Work is constantly in progress to increase your safety and efficiency during operation. Speak to your servicing dealer for more information.

Intended use

Use the product to blow leaves and other unwanted material from areas such as lawns, pathways and asphalt roads.

Symbols on the product



Warning! The blower can be dangerous! Careless or incorrect use can result in serious or fatal injury to the operator or others. It is extremely important that you read and understand the contents of the operator's manual. Please read the operator's manual carefully and make sure you understand the instructions before using the machine.



Use approved eye protection.



Direct current.



Noise emissions to the environment according to European Directive 2000/14/EC and New South Wales legislation "Protection of the Environment Operations (Noise Control) Regulation 2017". Noise emission data can be found on the machine label and in the Technical data chapter.



Symbols on the product or its packaging indicate that this product cannot be handled as domestic waste. This product must be deposited at an appropriate recycling facility.



The product agrees with the applicable EC directives.

IPX4

Protected against splashing water.



Warning LED



Start/Stop button



Boost mode button



Cruise control button



If the product features Bluetooth® wireless technology. The Bluetooth® symbol will be marked on the product name label. Refer to *Bluetooth® wireless technology on page 15*.



The blower operator must ensure that no people or animals come closer than 15 meters. When several operators are working at the same site a safety distance of at least 15 meters must be in effect. The blower can forcibly throw objects that can bounce back. This can result in serious eye injuries if the recommended safety equipment is not used.



yyyy ww xxxxx

The rating plate or the laser printing shows the serial number. **yyyy** is the production year, **ww** is the production week and **xxxxx** is the sequential number.

Product liability

As referred to in the product liability laws, we are not liable for damages that our product causes if:

- the product is incorrectly repaired.
- the product is repaired with parts that are not from the manufacturer or not approved by the manufacturer.
- the product has an accessory that is not from the manufacturer or not approved by the manufacturer.
- the product is not repaired at an approved service center or by an approved authority.

Safety

Safety definitions

Warnings, cautions and notes are used to point out specially important parts of the manual.



WARNING: Used if there is a risk of injury or death for the operator or bystanders if the instructions in the manual are not obeyed.



CAUTION: Used if there is a risk of damage to the product, other materials or the adjacent area if the instructions in the manual are not obeyed.

Note: Used to give more information that is necessary in a given situation.

Introduction



WARNING: Read all safety warnings and all instructions. Failure to follow the warnings and instructions may result in electric shock, fire and/or serious injury.

General power tool safety warnings

Check before starting

- Inspect the working area. Remove all loose objects, such as stones, broken glass, nails, steel wire, string etc. that could be thrown out.
- Always remove the battery to prevent the machine being started by accident. Always disconnect the battery before any maintenance on the machine.
- Before using the machine and after any impact, check for signs of wear or damage and repair as necessary.
- Only use original spare parts.
- The machine operator must ensure that no people or animals come closer than 15 metres while working. When several operators are working in the same area the safety distance should be at least 15 metres.
- Do an overall inspection of the machine before use, see maintenance schedule.
- National or local regulations may regulate the use. Comply to given regulations.

Personal safety

- **Stay alert, watch what you are doing and use common sense when operating a power tool. Do not use a power tool while you are tired or under the influence of drugs, alcohol or medication.** A moment of inattention while operating power tools may result in serious personal injury.
- Keep bystanders away.
- This appliance is not intended for use by person (including children) with reduced physical, sensory or mental capabilities, or lack of experience and knowledge, unless they have been given supervision or instruction concerning use of the appliance by a person responsible for their safety. Children should be supervised to ensure that they do not play with the appliance.
- Never allow children or other persons not trained in the use of the machine and/or the battery to use or service it. Local laws may regulate the age of the user.
- Keep unauthorised persons at a distance. Children, animals, onlookers and helpers should be kept outside the safety zone of 15 m (50 ft.). Stop the machine immediately if anyone approaches.
- Store the equipment in a lockable area so that it is out of reach of children and unauthorized persons.
- **Dress properly. Do not wear loose clothing or jewellery. Keep your hair, clothing and gloves away from moving parts.** Loose clothes, jewellery or long hair can be caught in moving parts.
- Never use the machine if you are tired, if you have drunk alcohol, or if you are taking medication that could affect your vision, your judgement or your coordination.
- Wear personal protective equipment. See instructions under the heading "Personal protective equipment".
- Always remove the battery when passing the machine to another person.
- Keep in mind that it is you, the operator that is responsible for not exposing people or their property to accidents or hazards.

Power tool use and care

- Never use a machine that has been modified in any way from

- its original specification. Never use the machine near explosive or flammable materials.
- Never use a machine that is faulty. Carry out the safety checks, maintenance and service instructions described in this manual. Some maintenance and service measures must be carried out by trained and qualified specialists. See instructions under the heading Maintenance.
 - Only use original spare parts.
 - Always ensure that ventilation openings are kept clear of debris.
 - All covers, guards and handles must be fitted before starting.
 - Only use the machine in daylight or in other well-lit conditions.
 - Never use the machine in bad weather, for instance in fog, in rain, damp or in wet locations, strong winds, intense cold, risk of lightning, etc. Extremely hot weather may cause overheating of the machine. Operation in bad weather is tiring and can lead to dangerous conditions, for instance slippery surfaces.

- If the machine starts vibrating abnormally, stop the machine and remove the battery.
- Walk, never run.

General safety instructions



WARNING: Read the warning instructions that follow before you use the product.

- Incorrect or careless use of the product can turn it into a dangerous tool that can cause serious or even fatal injury to the operator or others. You must read and understand the contents of this operator's manual.
- Under no circumstances may the design of the product be modified without the permission of the manufacturer. Never use a product that has been modified in any way from its original specification and always use original accessories. Non-authorized modifications and/or accessories can result in serious personal injury or the death of the operator or others. Your warranty may not cover damage or liability caused by the use of non-

authorized accessories or replacement parts.

- This product produces an electromagnetic field during operation. This field may under some circumstances interfere with active or passive medical implants. To reduce the risk of serious or fatal injury, we recommend persons with medical implants to consult their physician and the medical implant manufacturer before operating this product.
- Remove the battery from the product during charging.

Safety instructions for operation



WARNING: Read the warning instructions that follow before you use the product.

- If you encounter a situation where you are uncertain how to proceed you should ask an expert. Contact your dealer or your service workshop. Avoid all usage which you consider to be beyond your capability.
 - Do not allow children to use or be in the vicinity of the product. Since the product is easy to start, children may be able to start it if they are not kept under full surveillance.
- This can mean a risk of serious personal injury. Disconnect the battery when the product is not under close supervision.
- Ensure that no people or animals come closer than 15 meters (50 ft.) while you work. When several operators are working in the same area the safety distance should be at least 15 meters. Otherwise there is a risk of serious personal injury. Stop the product immediately if anyone approaches. Never swing the product around without first checking behind you to make sure that no one is within the safety zone.
 - Make sure that you can move and stand safely. Check the area around you for possible obstacles (roots, rocks, branches, ditches, etcetera) in case you have to move suddenly. Take great care when you work on sloping ground.
 - Keep a good balance and a firm foothold at all times. Do not overreach.
 - Listen out for warning signals or shouts when you wear hearing protection. Always remove your hearing

protection as soon as the product stops.

- Show consideration to persons in your surroundings by avoiding using the product at unsuitable times, such as late in the evening or early in the morning. Follow local regulations and ordinances.
- Do not operate the product near open windows.
- Use the product with the lowest possible airflow. It is seldom necessary to use full airflow, and many work procedures can be done at half airflow. A lower airflow means less noise and less dust, and it is also easier to keep control over the rubbish collected together/moved.
- Use a rake or a brush to release rubbish stuck to the ground.
- Hold the opening of the blower as close to the ground as possible.
- Observe your surroundings. Direct the product away from persons, animals, play areas, cars etc.
- Minimize the blowing time by lightly wetting dusty areas or using spray equipment.

- Be aware of the wind direction. Work with the wind to make your work easier.
- Stop the product and remove the battery if the product starts to vibrate abnormally.
- Using the product to move large piles is time consuming and creates unnecessary noise.
- Clean up afterwards. Make sure that you have not blown rubbish into someone's garden.
- Do not run with the product.
- The powerful currents of air can move objects at such a speed that they can bounce back and cause serious eye injuries.

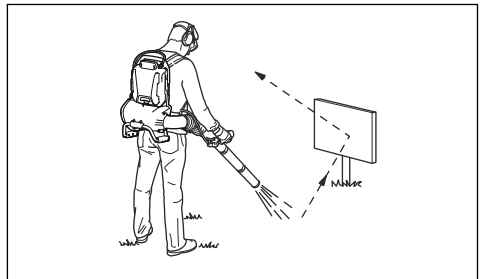

- Do not direct the airflow towards people or animals.
- Stop the motor before you assemble or dismantle accessories or other parts.
- Keep all parts of your body away from hot surfaces.

- Never put the product down when it is activated unless you have it in clear sight.
- The product must not be used while on a ladder or scaffolding.

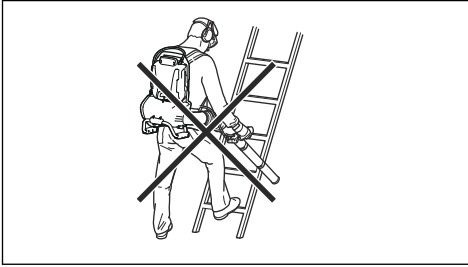

- Do not use the product unless you are able to call for help in case of an accident.
- Watch out for thrown objects. Stones, rubbish, etc., can be thrown up into the eyes causing blindness or serious injury.
- Use a residual-current device (RCD) for increased security during charging. A residual-current device is fitted to protect operators in case an electrical fault should occur.
- This product is renowned for its low vibration load. Overexposure to vibration can lead to circulatory damage or nerve damage in people who have impaired circulation. Contact your doctor if you experience symptoms of overexposure to vibration.

Such symptoms include numbness, loss of feeling, tingling, pricking, pain, loss of strength, changes in skin color or condition. These symptoms normally appear in the fingers, hands or wrists.

- Only use the product for the purpose it was intended for.
- It is not possible to cover every conceivable situation you can face. Always exercise care and use your common sense. Avoid all situations which you consider to be beyond your capability. If you still feel uncertain about operating procedures after reading these instructions, you should consult an expert before continuing.
- The harness must always be worn when working with the product. Failure to do so means you will be unable to manoeuvre safely and this can result in injury to yourself and/or others.

Personal protective equipment



WARNING: Read the warning instructions that follow before you use the product.

- Always use approved personal protective equipment when you use the product. Personal protective equipment cannot fully prevent injury but it decreases the degree of injury if an accident does occur. Let your dealer help you select the right equipment.
- Long term exposure to noise can result in damaged hearing. In general, battery powered products are relatively quiet but damage can result from a combination of noise level and long usage. recommends that operators use hearing protectors when using products for a longer coherent time of a day. Continual and regular users should have their hearing checked regularly. Note that hearing protectors limit the ability to hear sounds and warning signals.

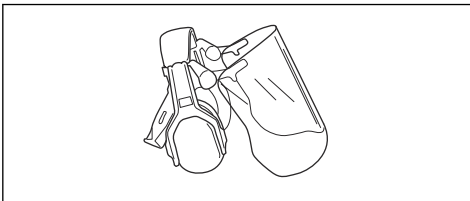

- Use approved eye protection. If you use a visor, you must also use approved protective goggles. Approved protective goggles must comply with the

ANSI Z87.1 standard in the USAs or EN 166 in EU countries.

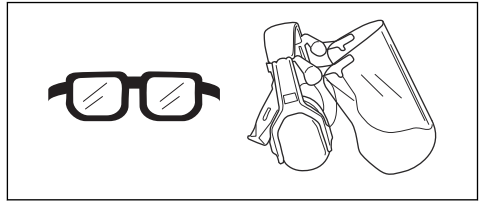

- Use clothing made of a strong fabric. Always use heavy, long pants and long sleeves. Do not use loose clothing that can catch on twigs and branches. Do not wear jewelry, short pants, sandals or go with bare feet. Put your hair up safely above shoulder level.
- Keep first aid equipment close at hand.

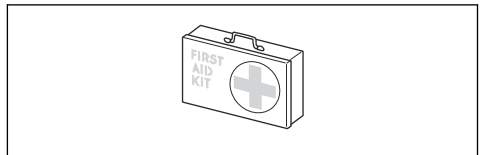

- A breathing mask should be used when there is a risk of dust.

Safety devices on the product



WARNING: Read the warning instructions that follow before you use the product.

- In this section the product's safety features, its purpose and how checks and maintenance should be carried out to ensure that it operates correctly. See instructions under the heading *Product overview on page 2* to find where these parts are located on your product.
- The life span of the product can be reduced and the risk of accidents can increase if product maintenance is not carried out correctly and if service and/or repairs are not carried out professionally. If you need further information please contact your nearest servicing dealer.
- Never use a product with defective safety components. The product's safety equipment must be inspected and maintained as described in this section. If your product fails any of these checks, contact your service agent to get it repaired.
- All servicing and repair work on the product requires special training. This is especially true of the product's safety equipment. If your product fails any of the checks described below you must contact your service

agent. When you buy any of our products we guarantee the availability of professional repairs and service. If the retailer who sells your product is not a servicing dealer, ask him for the address of your nearest service agent.

To do a check of the user interface

1. Push and hold the start/stop button (A).

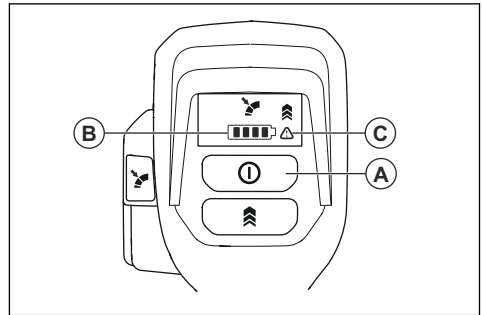

- a) The product is on, when the LED (B) is on.
 - b) The product is off, when the LED (B) is off.
2. Refer to *User interface on page 18* if the warning indicator (C) is on or flashes.

To do a check of the power trigger

- Push and release the power trigger to make sure that it moves freely.

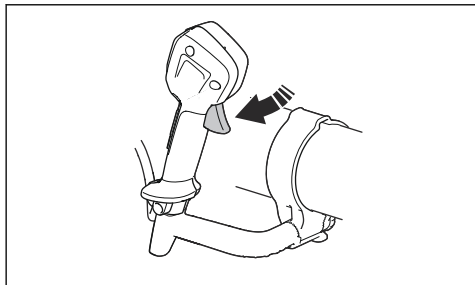

Harness safety



WARNING: Read the following warning before you operate the product.

The harness must always be worn when working with the product. Failure to do so means you will be unable to operate safely and this can result in injury to yourself or others. Make sure that the waist belt and chest belt are buttoned and correctly adjusted. There is a risk that an unclosed belt can get stuck or sucked into the fan of the product.

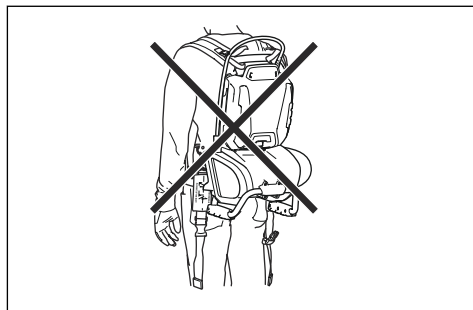

To use the quick release function

If an emergency occurs, remove the backpack blower quickly.

1. Push the clips and remove the straps.

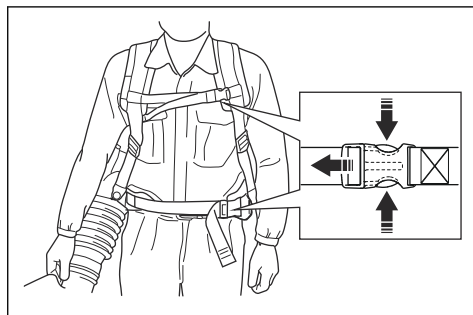

2. Remove the harness.

Safety instructions for maintenance



WARNING: Read the warning instructions that follow before you do maintenance on the product.

- Remove the battery before you do maintenance, other checks or assemble the product.
- The operator must only do the maintenance and servicing shown in this operator's manual. Speak to your servicing dealer for maintenance and servicing of a larger extension.
- Keep all nuts, bolts and screws tight to be sure the product is in safe working condition.
- Replace worn or damaged parts.
- If you do not do maintenance, it decreases the life cycle of the product and increases the risk of accidents.
- Special training is necessary for all servicing and repair work, especially for the safety devices on the product. If not all checks in this operator's manual are approved after maintenance, speak to your servicing dealer. We guarantee that there are professional repairs and servicing available for your product.
- Only use original spare parts.

Assembly

Introduction



WARNING: Read and understand the safety chapter before you assemble the product.

To assemble the tube and handle on the product

1. Put the clamp (B) on the flexible tube (C) and attach the flexible tube to the blower outlet (A).

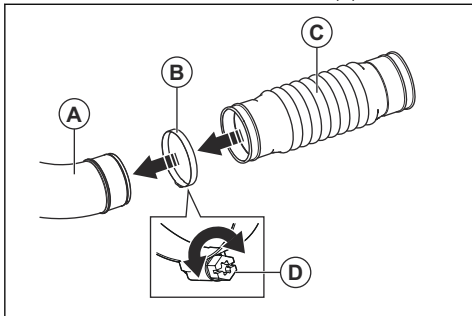

2. Make sure to put the clamp screw (D) as the illustration shows. Tighten the screw.

3. Attach the transport strap (O) to the guide track of the joint swivel (H).

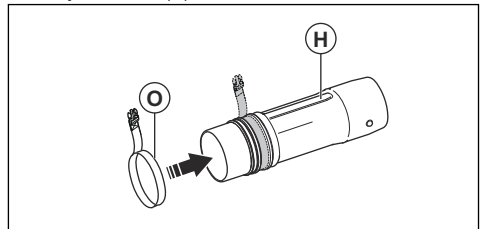

4. Put the clamp (B) on the flexible tube (C) and attach the joint swivel (H).

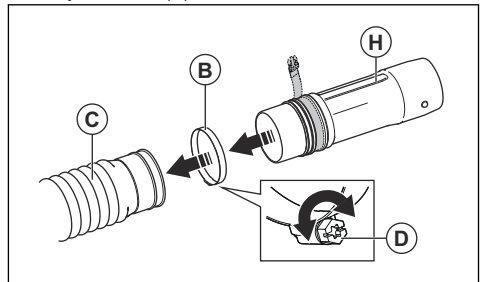

5. Make sure to put the clamp screw (D) as the illustration shows. Tighten the screw.

- Align the knobs (J) to each side of the joint swivel (H).
- Attach the control handle (I) to the guide track (K) of the joint swivel (H). Make sure that the screw on the control handle is on the bottom side of the control pipe.

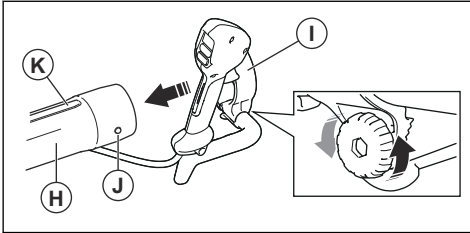

- Tighten the screw on the control handle fully.
- Connect the intermediate pipe (L) to the joint swivel (H). Make sure that the knob (J) aligns with the guide track of the intermediate pipe.

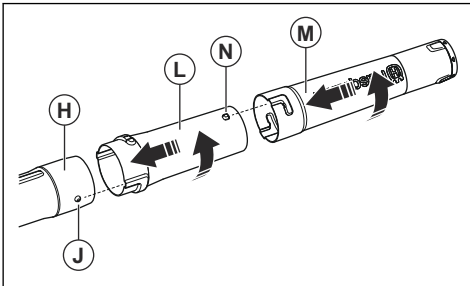

- Turn the intermediate pipe fully to lock the control pipe and the intermediate pipe.
- Connect the blow pipe (M) to the intermediate pipe (L). Make sure that the knob (N) on the intermediate pipe points up and goes into the guide track of the blow pipe.
- Turn the blow pipe fully to lock the intermediate pipe and the blow pipe.
- Attach the sleeve around the flexible tube and the cable as shown in the illustration. Close the zipper.

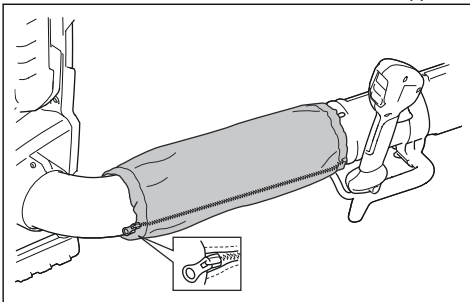

To adjust the harness

A correctly adjusted harness and product makes operation easier. Adjust the harness to give the best operation position.

- Put on the harness of the product.

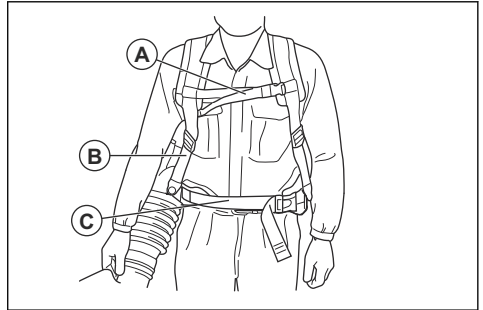

- Connect the hip strap with the clip (C). Tighten the strap until the weight of the product is on your hips.
- Tighten the side straps (B) until the product is tight against your body.
- Connect the chest strap to the clip (A).
- Tighten the strap.

To put the product in transportation mode

- Turn the blower tube counterclockwise until it points up.

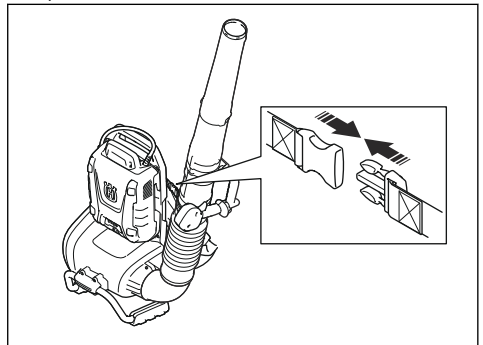

- Connect the transport clip.

Operation

Introduction



WARNING: Read and understand the safety chapter before you use the product.

Husqvarna Connect

Husqvarna Connect is a free app for your mobile device. The Husqvarna Connect app gives extended functions for your Husqvarna product.

- Extended product information.
- Information about, and help with, product parts and servicing.

Bluetooth® wireless technology

Products with built-in Bluetooth® wireless technology can connect to mobile devices and enables additional functions.

The symbol for Bluetooth® wireless technology shows up when your mobile device is connected to the product.

To start to use Husqvarna Connect

1. Download the Husqvarna Connect app on your mobile device.
2. Register in the Husqvarna Connect app.
3. Follow the instruction steps in the Husqvarna Connect app to connect and register the product.

Note: Husqvarna Connect app is not available for download in all markets.

To connect the battery to the product



WARNING: Only use Husqvarna original batteries in the product.

1. Make sure that the battery is fully charged.
2. Pull out the locking handles.

3. Install the battery in the backpack holder.

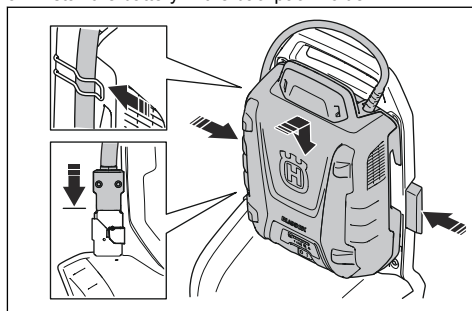

4. Push the locking handles to lock the battery.
5. Connect the cable to the connector.
6. Put the cable in the clip on the backpack holder.

To start the product

1. To start the backpack battery, push the start button on the backpack battery. Do not continue with the steps that follow before the green LED lights is on.

Note: When the backpack battery starts, there is a startup time of approximately 4 seconds. During the startup the fans come on and green LED lights on the battery flashes. When the green LED lights on the battery are on, the product is prepared for start.

2. Push and hold the start button until the green LED lights on the user interface come on.

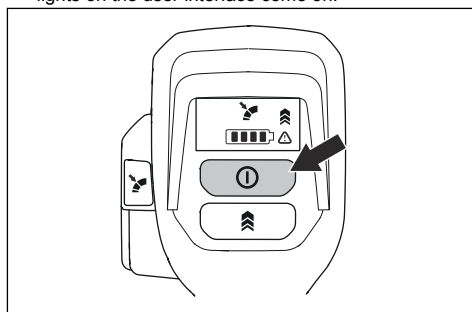

To stop the product

1. Release the power trigger.
2. Push and hold the stop button until the green LED light goes out.
3. Remove the cable from the clip on the backpack holder.

4. Pull the locking handles to unlock the battery.

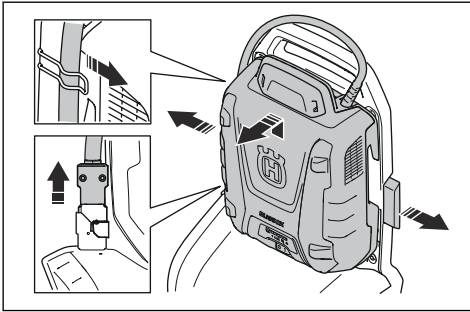

5. Disconnect the cable from the connector.
6. Remove the battery from the product.

Note: If the backpack battery is not used for more than 30 minutes, the backpack battery stops automatically. To start the backpack battery, push the start button on the backpack battery.

To operate the product

1. Push the power trigger to select the optimal airflow for your work.

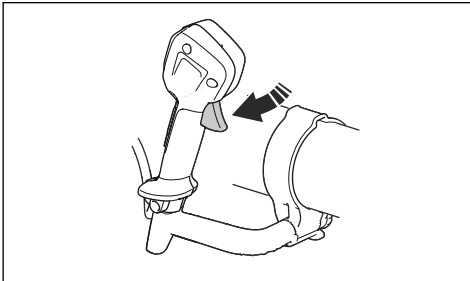

2. Push the Cruise control button to set the selected airflow, the LED comes on.

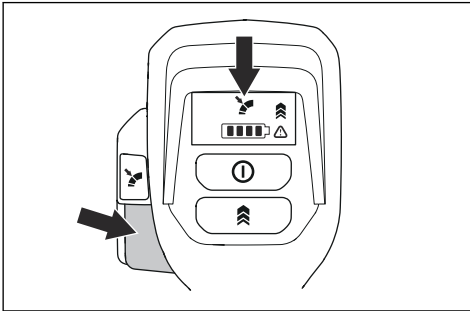

3. Continue to operate with the selected airflow. It is not necessary to push the power trigger.
4. To increase the airflow, push the power trigger. When the power trigger is released, the airflow goes back to the airflow that was set in step 2.
5. Release the power trigger and push the Cruise control button to stop the Cruise control function.

To increase the airflow to maximum

1. Start the product. Refer to *To start the product on page 15*.
2. Push the Boost mode button to enable maximum airflow when the power trigger is pushed. The LED comes on to show that the Boost mode function is on. The Boost mode function has no time limit.

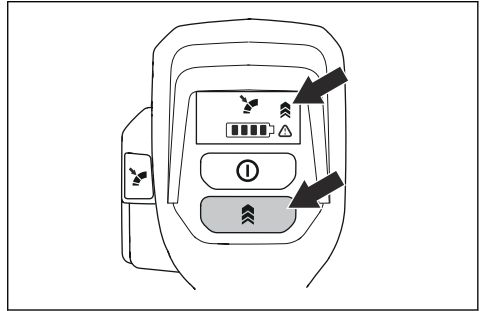

3. Push the Boost mode button again to stop the Boost mode function.

Maintenance

Introduction



WARNING: Before you do any maintenance work you must read and understand the safety chapter.

Maintenance schedule

Maintenance	Daily	Weekly	Monthly
Clean the external surfaces of the product with a clean and dry cloth. Do not use water.	X		
Keep the handles dry and clean. Remove oil or grease.	X		
Make sure that the Start/Stop button operates correctly and is not damaged.	X		
Make sure that the power trigger operates correctly.	X		
Make sure that nuts and screws are tight.	X		
Make sure that the release buttons on the battery operates correctly and locks the battery into position.	X		
Make sure that all couplings, connections and cables are not damaged. Remove dirt.		X	
Make sure that the battery connectors are not damaged.			X

To do a check of the air intake

1. Make sure that the air intake is not blocked.

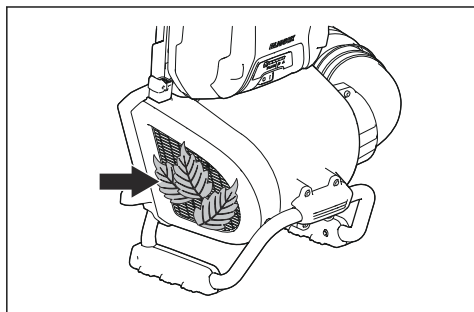

2. Stop the product and remove unwanted material if it is necessary.



CAUTION: A blocked air intake decreases the performance of the

product and can cause the motor to become too hot.

To clean the product, the battery and the battery charger

1. Clean the product with a dry cloth after use.
2. Clean the battery and battery charger with a dry cloth. Keep the battery guide tracks clean.
3. Make sure that these parts are clean before the battery is connected to the battery charger or the product:
 - a) The terminals on the backpack battery cable.
 - b) The terminals on the backpack battery adapter.
 - c) The terminals on the battery charger.
 - d) The terminals on the backpack blower.

Troubleshooting

User interface

User interface	Possible faults	Possible action
Green LED Flashes	Low battery voltage.	Charge the battery.
Red error LED flashes	Temperature deviation.	Let the product cool down.
The product does not start	Dirt in battery connectors.	Clean with compressed air or a soft brush.
	The battery is off.	Start the battery.
Red error LED flashes	The product needs servicing.	Contact your servicing agent.

Transportation, storage and disposal

Transportation and storage

- Obey the special requirement on package and labels for commercial transportations, including by third parties and forwarding agents.
- Speak to a person with special training in dangerous material before you send the product. Obey all applicable national regulations.
- Remove the battery for storage or transportation.
- Clean the product and do a full servicing before you put the product in storage for a long time.
- Store the appliance only in a dry place.
- Attach the product safely during transportation.

Disposal of the battery, battery charger and product

The symbol below means that the product is not domestic waste. Recycle it at a recycling station for

electrical and electronic equipment. This helps to prevent damage to the environment and to persons.

Speak to local authorities, domestic waste service or your dealer for more information.

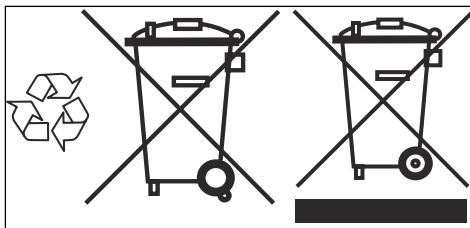

Note: The symbol shows on the product or package of the product.

Technical data

Technical data

	550IBTX
Motor	
Motor type	BLDC (brushless) 36V
Weight	
Weight without battery, kg/ lb	6.3/13.9

	550iBTX
Noise emissions¹	
Sound power level, measured dB (A)	95
Sound power level, guaranteed L _{WA} dB (A)	96
Water protection level	
All weather use	Yes
IPX4 ²	Yes
Sound levels³	
Equivalent sound pressure level at the operator's ear, measured according to EN ISO 11203 and ISO 22868, dB (A):	76
Vibration levels⁴	
Vibrations levels at handles, measured according to ISO 22867, m/s ²	0.1
Fan performance	
Airflow in normal mode with round standard nozzle, m ³ /min	12.8
Airflow in Boost mode with round standard nozzle, m ³ /min	15.6
Maximum air velocity in normal mode with round standard nozzle, m/s / mph	54 / 120.8
Maximum air velocity in Boost mode with round standard nozzle, m/s / mph	66 / 147.6
Maximum blow force in normal mode with round standard nozzle, N	14
Maximum blow force in Boost mode with round standard nozzle, N	21
Radio frequency data for Bluetooth®	
Frequency band, GHz	2.4-2.4835
Output power, max dBm 0	0

Noise and vibration data are determined on the basis of the rated maximum speed.

Approved batteries

Only use original Husqvarna BLI batteries for this product

Battery	BLI 950X	BLI 550X
Type	Lithium-ion	Lithium-ion
Battery capacity, Ah	31.1	15.6

¹ Noise emissions in the environment measured as sound power (L_{WA}) in conformity with EC directive 2000/14/EC. Reported sound power level for the machine has been measured with the original attachment that gives the highest level. The difference between guaranteed and measured sound power is that the guaranteed sound power also includes dispersion in the measurement result and the variations between different machines of the same model according to Directive 2000/14/EC.

² The Husqvarna Handheld Battery products marked with IPX4 fulfils these requirements on product approval level

³ Reported data for equivalent sound pressure level for the machine has a typical statistical dispersion (standard deviation) of 3 dB (A).

⁴ Reported data for vibration level has a typical statistical dispersion (standard deviation) of 2 m/s².

Battery	BLi 950X	BLi 550X
Nominal voltage, V	36	36
Weight, kg/lb	6.9/15.3	5.6/12.4

Approved battery chargers

Battery charger	QC330	QC500
Input voltage, V	100-240	100-240
Frequency, Hz	50-60	50-60
Power, W	330	500

Accessories

Approved accessories

Approved accessories	Type	Art. no.
Nozzle (length)	Flat Nozzle (600 mm)	579 79 75-01
	Round Nozzle with metal ring (300 mm)	586 10 63-01
	Nozzle Silencer (400 mm)	589 81 17-01
	Nozzle	576 58 18-01
Handlebar	Handlebar	544 40 00-04

EC Declaration of Conformity

EC Declaration of conformity

Husqvarna AB, SE-561 82 Huskvarna, Sweden, tel: +46-36-146500, declare that the backpack blower **Husqvarna 550IBTX** (with or without Bluetooth functionality), with serial numbers dating from 2020 onwards (the year is clearly stated on the rating plate, followed by the serial number), comply with the requirements of the COUNCIL'S DIRECTIVE:

- - of May 17, 2006 "relating to machinery" **2006/42/EC**.
- - of April 16, 2014 "relating to Radio Equipment" **2014/53/EU**.
- - of February 26, 2014 "relating to electromagnetic compatibility" **2014/30/EU**.
- - of May 8, 2000 "relating to the noise emissions in the environment" **2000/14/EC**.
- - of June 8, 2011 on the "restriction of use of certain hazardous substances in electrical and electronic equipment" **2011/65/EU**.

The following standards have been applied:

EN 60335-1:2012+A13:2017, EN 50636-2-100:2014 (IEC 60335-2-100:2002), EN 61000-6-1:2007, EN 61000-6-3:2007+A1:2011, EN 63000:2018

For products with Bluetooth functionality also:

ETSI EN 301 489-1 v.2.1.1, ETSI EN 301 489-17 v.3.1.1, EN 300 328 v.2.2.2

RISE SMP Svensk Maskinprovning AB, has carried out a voluntary examination on behalf of **Husqvarna AB**. The certificate has the number: **01/012/006**

Notified body 0404: RISE SMP Svensk Maskinprovning AB has also verified agreement with appendix VII of the Council's directive 2000/14/EC.

For information relating to noise emissions, refer to *Technical data on page 18*.

Huskvarna, 2021-02-20



Pär Martinsson, Development Manager (Authorized representative for Husqvarna AB and responsible for technical documentation.)

Registered trademarks

The *Bluetooth*[®] word mark and logos are registered trademarks owned by and any use of such marks by Husqvarna is under license.



www.husqvarna.com

Original instructions

1142148-26



2021-02-26