

2023



For Maintenance and Safety

OWNER'S MANUAL

RANGER XP 1000
RANGER CREW XP 1000

POLARIS
Think Outside



WARNING

Read, understand, and follow all of the instructions and safety precautions in this manual and on all product labels.

Failure to follow the safety precautions could result in serious injury or death.



WARNING

Operating, servicing, and maintaining a passenger vehicle or off-road vehicle can expose you to chemicals including engine exhaust, carbon monoxide, phthalates, and lead, which are known to the State of California to cause cancer and birth defects or other reproductive harm. To minimize exposure, avoid breathing exhaust, do not idle the engine except as necessary, service your vehicle in a well-ventilated area and wear gloves or wash your hands frequently when servicing your vehicle.

For more information go to www.P65Warnings.ca.gov/passenger-vehicle.



*For videos and more information
about a safe riding experience with
your Polaris vehicle, scan this QR
Code® with your smartphone
or visit: www.polaris.com/en-us/safety*

POLARIS
RANGER[®]

2023 Owner's Manual

RANGER XP 1000

Premium

NorthStar Edition Premium

NorthStar Edition Trail Boss

NorthStar Edition Ultimate

RANGER CREW XP 1000

Premium

Texas Edition

NorthStar Edition Premium

NorthStar Edition Trail Boss

NorthStar Edition Ultimate

RANGER CREW XP 1000 MD

RANGER XP 1000 HD

Unless noted, trademarks are the property of Polaris Industries Inc.

Recreational Off-Highway Vehicle Association® and ROHVA® are registered trademarks of Recreational Off-Highway Vehicle Association. BatteryMINDER® is a registered trademark of VDC Electronics Inc. Loctite® is a registered trademark of Henkel Corporation. NYOGEL® is a registered trademark of Nye Lubricants, Inc. WD-40® is registered to WD-40 Manufacturing Company. QR Code® is a registered trademark of DENSO WAVE INCORPORATED. Maxxis® is a registered trademark of Cheng Shin Rubber Ind. Co., Ltd. Apple® and APP STORE® are registered trademarks of Apple Inc. ANSI® is a registered trademark of American National Standards Institute, Inc. Bluetooth® is a registered trademark of Bluetooth Sig, Inc. Google Play® is a registered trademark of Google, Inc. Sandisk® is a registered trademark of SANDISK LLC. exFAT® is a registered trademark of Microsoft Corporation. OSHA® is a registered trademark of the Occupational Safety and Health Administration, U. S. Dept. of Labor. MACPHERSON RIDE® is a registered trademark of Aftermarket Auto Parts Alliance, Inc. Tread Lightly® is a registered trademark of the United States Department of Agriculture. Carlisle® is a registered trademark of CARLISLE INTANGIBLE, LLC.

Copyright 2023 Polaris Industries Inc. All information contained within this publication is based on the latest product information at the time of publication. Due to constant improvements in the design and quality of production components, some minor discrepancies may result between the actual vehicle and the information presented in this publication. Depictions and/or procedures in this publication are intended for reference use only. No liability can be accepted for omissions or inaccuracies. Any reprinting or reuse of the depictions and/or procedures contained within, whether whole or in part, is expressly prohibited.

The original instructions for this vehicle are in English. Other languages are provided as translations of the original instructions.

Printed in U.S.A.

9941181 R01



Thank you for purchasing a POLARIS vehicle, and welcome to our world-wide family of POLARIS enthusiasts. Be sure to visit us online at www.polaris.com for the latest news, new product introductions, upcoming events, career opportunities and more.

Here at POLARIS we proudly produce an exciting line of utility and recreational products. We believe POLARIS sets a standard of excellence for all utility and recreational vehicles manufactured in the world today. Many years of experience have gone into the engineering, design, and development of your POLARIS vehicle, making it the finest machine we've ever produced.

For safe and enjoyable operation of your vehicle, be sure to follow the instructions and recommendations in this owner's manual. Your manual contains instructions for minor maintenance, but information about major repairs is outlined in the POLARIS Service Manual and can be performed by a factory certified Master Service Dealer (MSD) technician.

Your POLARIS dealer knows your vehicle best and is interested in your total satisfaction. Your POLARIS dealership can perform all of your service needs during and after the warranty period.

For the most up-to-date owner's manual visit <https://www.polaris.com/en-us/owners-manuals>.

WELCOME

| | |
|---|------------|
| Introduction | 7 |
| Safety | 15 |
| Features and Controls | 45 |
| Ride Command Display (if equipped) | 73 |
| Operation | 83 |
| Emission Control Systems | 97 |
| Maintenance | 99 |
| Specifications | 147 |
| POLARIS Products | 161 |
| Troubleshooting | 163 |
| Warranty | 167 |
| Maintenance Log | 177 |

INTRODUCTION

BEFORE YOU RIDE

This POLARIS vehicle is an off-road vehicle. Familiarize yourself with all laws and regulations concerning the operation of this vehicle in your area.

WARNING

Failure to heed the warnings and safety precautions contained in this manual can result in severe injury or death. Your POLARIS vehicle is not a toy and can be hazardous to operate. This vehicle handles differently than cars, trucks or other off-road vehicles. A collision or rollover can occur quickly, even during routine maneuvers like turning, or driving on hills or over obstacles, if you fail to take proper precautions.

- Read this owner's manual and review the safety DVD that came with your vehicle. A free extra copy of the DVD can be obtained by contacting your local POLARIS dealer. Understand all safety warnings, precautions and operating procedures before operating the vehicle. Keep this manual with the vehicle.
- Never operate this vehicle without proper instruction. Take an authorized training course. See the Safety Training section for more information.
- This vehicle is an **ADULT VEHICLE ONLY**. You **MUST** be at least age 16 and have a valid driver's license to operate this vehicle.
- Always use the cab nets (or doors) while riding in this vehicle. Always keep hands, feet and all other body parts inside the vehicle at all times.
- Always wear a helmet, eye protection, gloves, long-sleeve shirt, long pants and over-the-ankle boots.
- Never operate this vehicle under the influence of drugs or alcohol, as these conditions impair judgement and reduce the operator's ability to react.
- Complete the New Operator Driving Procedures outlined in this manual. Never allow a guest to operate this vehicle until the guest has completed the New Operator Driving Procedures.
- Never permit a guest to operate this vehicle unless the guest has reviewed the owner's manual and all safety labels and has completed a safety training

INTRODUCTION

SAFETY SYMBOLS AND SIGNAL WORDS

The following signal words and symbols appear throughout this manual and on your vehicle. Your safety is involved when these words and symbols are used. Become familiar with their meanings before reading the manual.

DANGER

DANGER indicates a hazardous situation which, if not avoided, WILL result in death or serious injury.

WARNING

WARNING indicates a hazardous situation which, if not avoided, COULD result in death or serious injury.

CAUTION

CAUTION indicates a hazardous situation which, if not avoided, COULD result in minor to moderate injury.

NOTICE

NOTICE provides key information by clarifying instructions.

IMPORTANT

IMPORTANT provides key reminders during disassembly, assembly, and inspection of components.

The Prohibition Safety Sign indicates an action NOT to take in order to avoid a hazard.



The Mandatory Action Sign indicates an action that NEEDS to be taken to avoid a hazard.



NEAR-FIELD COMMUNICATION (NFC) (IF EQUIPPED)

Some Polaris vehicles come equipped with a near-field communication (NFC) chip. The NFC chip is embedded in the Polaris emblem located at the front of the vehicle and seamlessly connects you to a digital platform of vehicle information and tools. See your dealer for more information.

IMPORTANT

Not all devices are equipped with an NFC reader. Additionally, some devices require third party applications to access NFC content. For questions regarding the NFC reader on your device, refer to the device's user manual.

On models equipped with NFC, place your smartphone directly over the Polaris emblem to do the following:

- View vehicle-specific information
- Access your Polaris Garage
- Download and view the owner's manual
- View accessory instructions
- Watch how-to videos
- Access warranty information
- Check for service notifications



RIDE COMMAND WITH NFC

Additional NFC features are available when using the Ride Command mobile app. To access these features, do the following:

1. Download the Ride Command mobile app from the Apple App Store® or Google Play® store.
2. Create or log in to an existing account.
3. From the Ride Command mobile app home screen, select **Add Vehicle**.
4. On the vehicle, tap the NFC-enabled badge with the phone to scan the vehicle.
5. Confirm information, name your vehicle, and tap add to garage.

SYSTEM REQUIREMENTS

Refer to device manufacturer's instructions to verify NFC read capability, and/or NFC-capable add-ons.

INTRODUCTION

EUROPEAN VIBRATION AND NOISE

The driver-perceived noise and hand/arm and whole body vibration levels of this machinery is measured per EN 16990.

| | | RANGER XP 1000 CREW |
|-----------|--|--------------------------------|
| Noise | A-Weighted Sound Pressure Level at Rider's Ear | 79.7 dB(A) |
| | C-Weighted Sound Pressure Level at Rider's Ear | 98.3dB(C) |
| | A-Weighted Sound Power Level | n/a |
| Vibration | Weighted Hand-Arm Vibration Level | < 2.5 m/s ² |
| | Weighted Seat Vibration Level | 0.6 m/s ² |

Noise emission values are determined according to Annex F of EN 16990:2020.

Vibration values are determined according to Annex F or EN 16690.2020.

The measured noise and vibration values are for stationary vehicles. Noise and vibration values during operation/ traveling in foreseeable normal use of the vehicles are not significantly different.

DECLARATION OF CONFORMITY

PL-OP-HM-TM-0105-R03

| | | |
|---|---------------------|--|
| POLARIS | | Polaris Sales Europe Sàrl Place de l'Industrie 2 1180 Rolle, Switzerland Telephone: +41 213-218-700 |
| DECLARATION OF CONFORMITY | | |
| March 1, 2022 Rolle, Switzerland | | |
| Polaris Sales Europe Sàrl, declares that the vehicle(s) listed below conform to the essential requirements applicable to all terrain vehicles. This Declaration of Conformity is issued under the sole responsibility of the Manufacturer. | | |
| CE | | UK CA |
| APPLICABLE EUROPEAN DIRECTIVES 2006/42/EC as amended (Machinery Directive) 2014/30/EU as amended (EMC Directive) | | APPLICABLE UK REGULATIONS Supply of Machinery (Safety) Regulations 2008 Electromagnetic Compatibility Regulations 2016 |
| APPLICABLE HARMONISED STANDARDS EN ISO 12100, 2010 Hazard Analysis EN 1690:2020/AC 2012 Driver Perceived Noise Level & Vibration UNECE R18 | | APPLICABLE UK DESIGNATED STANDARDS |
| MODEL | TRADE NAME | VEHICLE SERIAL NUMBER |
| R23RSE99NJ | RANGER XP 1000 CREW | ----- |
| European Community Authorized Representative: Polaris Poland Sp. z o.o. ul. Wspólna 12, 45-637 Opole, Poland European Community Person Authorized to Compile the Technical File: Lukasz Góral, Product Homologation Specialist Polaris Poland Sp. z o.o. ul. Wspólna 12, 45-637 Opole, Poland | | Authorized Manufacturer Signatory Empowered to Draw Up the EC Declaration of Conformity:  Rene Basse Vice President EMEA |

| | | |
|--|--|--|
| POLARIS | | Polaris Sales Europe Sàrl Place de l'Industrie 2 1180 Rolle, Switzerland Telephone: +41 213-218-700 |
| SUPPLEMENT TO THE OWNER'S MANUAL INFORMATION REGARDING EMISSION OF AIRBORNE NOISE AND VIBRATION PRODUCED BY THE MACHINERY AND CARBON DIOXIDE (CO₂) EMISSION | | |
| A-Weighted Sound Pressure at Rider's Ear dB (A) | C-Weighted Sound Pressure Level dB (C) | A-Weighted Sound Power Level dB (A) |
| 69 | 85 | N/A |
| Weighted Hand-Arm Vibration Level m/s ² | Weighted Seat Vibration Level m/s ² | |
| 0.7 | 0.09 | |
| Carbon Dioxide (CO ₂) Emission g/kWh | | |
| 1011 | | |
| This CO ₂ measurement results from testing over a fixed test cycle under laboratory conditions a(n) (parent) engine representative of the engine type (engine family) and shall not imply or express any guarantee of the performance of a particular engine. | | |

This document is setting out the contents of the EC Declaration of Conformity.
The particulars of machinery may differ for specific model.

INTRODUCTION

RADIO COMPLIANCE STATEMENTS

NOTE

Some vehicle models contain radio equipment as detailed in this section.

USA RADIO COMPLIANCE

This vehicle contains the following radio equipment or components that contain radio equipment:

| COMPONENT | COMPONENT ID | MANUFACTURER |
|---------------------|--------------|-------------------------|
| 9200 Series Display | RC-7 | Polaris Industries Inc. |

This device complies with part 15 of the FCC Rules. Operation is subject to the following two conditions: (1) This device may not cause harmful interference, and (2) this device must accept any interference received, including interference that may cause undesired operation.

CAUTION

Changes or modifications not expressly approved by the party responsible for compliance could void the user's authority to operate the equipment.

CANADA RADIO COMPLIANCE

This vehicle contains the following radio equipment or components that contain radio equipment:

| COMPONENT | COMPONENT ID | MANUFACTURER |
|---------------------|--------------|-------------------------|
| 9200 Series Display | RC-7 | Polaris Industries Inc. |

This device contains license-exempt transmitter(s)/receiver(s) that comply with Innovation, Science and Economic Development Canada's license-exempt RSS (s). Operation is subject to the following two conditions:

1. This device may not cause interference.
2. This device must accept any interference, including interference that may cause undesired operation of the device.

IMPORTANT

For applications that use vehicle-to-vehicle (V2V) communication, radio transmitter IC 5966A-P001 has been approved by Innovation, Science and Economic Development Canada (ISED) to operate with Polaris antenna (part number 4018713) with gain of 3 dBi. Any antenna that has a gain greater than 3 dBi is prohibited for use with this device.

EUROPEAN UNION (EU) RADIO COMPLIANCE

This vehicle contains the following radio equipment or components that contain radio equipment:

| | |
|--|-------------------------|
| Component | 9200 Series Display |
| Component ID | RC-7 |
| Manufacturer | Polaris Industries Inc. |
| *Transmitting Frequency | 2402 - 2480 MHz |
| Max RF Transmitting PWR | 0.2432 W |
| *Other transmitting radio frequencies may exist outside of EU markets. | |

Hereby, Polaris Industries Inc. declares that the above radio equipment is in compliance with Directive 2014/53/EU.

The full text of the EU declaration of conformity is available at the following internet address:

<https://www.polaris.com/en-us/radio-conformity/>

INTRODUCTION

VEHICLE IDENTIFICATION NUMBERS

Record your vehicle's identification numbers and key number in the spaces provided. Remove the spare key and store it in a safe place. An ignition key can be duplicated only by ordering a POLARIS key blank (using your key number) and mating it with one of your existing keys. The ignition switch must be replaced if all keys are lost.

NOTICE

The images below are for reference only. Depending on model, your vehicle may differ slightly.

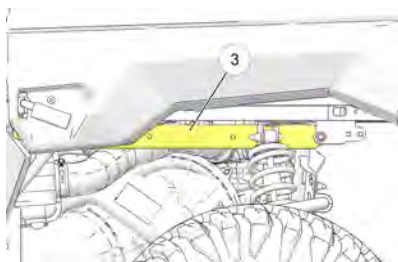
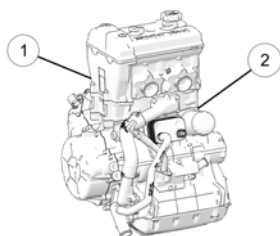

The engine serial number can be found on a decal applied to the front of the engine crankcase ① or stamped into the crankcase on the PTO side of the engine ②. The NRMM label can also be found in either location (if applicable).

The VIN can be found stamped on a portion of the left rear frame ③, above the PVT cover.

| | |
|--|--|
| Vehicle Model Number: | |
| Vehicle Identification Number (VIN): | |
| Engine Serial Number: | |
| Key Number: | |
| NRMM Reference Number (if applicable): | |

SAFETY

OWNER REQUIREMENTS

Improper use, maintenance, or modification of this vehicle can lead to serious injury or death.

Require proper use of your vehicle. Do not allow anyone to operate your vehicle or ride as a passenger unless they are properly instructed and you are sure they are willing to ride responsibly. To prevent unauthorized use, always remove the ignition key when the vehicle is not in use.



Any modifications or installation of non-POLARIS-approved accessories could increase the risk of injury. While you may find aftermarket products similar in design and quality to POLARIS accessories, recognize that some aftermarket accessories or modifications are not suitable because of potential safety hazards to you or others. It is never appropriate to install any additional seating.

Check with the manufacturer to determine any potential effect of a modification or accessory on the safe use of your vehicle. You are responsible for injuries related to modifications to the vehicle. Modifications or accessories may:

- Damage machine components - especially modifications that increase speed or power.
- Make the vehicle less stable at higher speeds.
- Add weight, reducing the amount of cargo and total weight you can carry, and raise the vehicle's center of gravity.
- Overload the vehicle's electrical system capacity. Blowing a fuse may cause a loss of lights or engine power.
- Reduce the effectiveness of occupant protection systems, including the seatbelts and the Rollover Protective Structure (ROPS).
- Make it illegal to own or operate your vehicle. POLARIS-authorized spark arresters, mufflers, and emissions control components are mandatory for ownership or operation in many areas.
- Void your warranty.

The vehicle ROPS, when used with the seat belts and doors, provides a structure to help protect occupants. The structure will not protect occupants in all rollovers or accidents.

For more information about safety, contact an authorized dealer or visit the Polaris website at www.polaris.com.

DRIVER AND PASSENGER QUALIFICATIONS

Make sure operators are 16 or older with a valid driver's license. Just because a teenager has a license does not mean that they will make good judgments about driving and avoid risk taking.

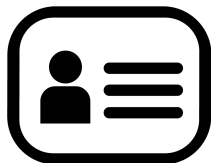

POLARIS recommends that you supervise younger drivers. Set rules and put limits on how, when, and where they are allowed to use this vehicle. For example, young drivers may need to have an adult in the vehicle with them and not be allowed to drive with their friends in the vehicle.

Make sure all riders fit the vehicle. Be sure that the driver and all passengers are able to:

- sit with their backs against their seat,
- adjust the seat belt to fit properly,
- have both feet flat on the floor, and
- have both hands on the steering wheel or on a passenger hand hold.

Do not allow children who need child safety seats or booster seats to ride in the vehicle. The vehicle is not designed to restrain automotive child safety seats.

You are responsible for your passengers. Be sure passengers are seated properly, belted, holding the passenger hand hold, and ready to brace. Unrestrained riders can fall out or be thrown around and from a moving vehicle.

Every person must be properly seated and belted in their own seat. Two people should never be belted into a single seat belt. People belted together can crash into one another in a collision and be seriously injured. Never carry passengers in the cargo bed as they could be thrown against or out of the vehicle or come into contact with moving parts.

Do not let people drive or ride after using alcohol or drugs.

PREPARE VEHICLE FOR THE RIDE

Before starting off, always perform the Pre-Ride Inspection. Failure to inspect and verify that the vehicle is in safe operating condition increases the risk of an accident, which can lead to serious injury or death.



| ITEM | REMARK | REFERENCE |
|-----------------------------------|------------------------------------|---------------------|
| Brake Fluid | Ensure proper level and condition | page 124 |
| Front and rear suspension | Inspect | — |
| Steering | Ensure free operation | page 127 |
| Tires | Inspect condition and pressure | page 35 page 129 |
| Wheels/Lug Nuts | Inspect, ensure fastener tightness | page 129 |
| Fuel and oil | Ensure proper levels and condition | page 104 |
| Coolant | Ensure proper level and condition | page 113 |
| Indicator lights/switches | Ensure proper operation | page 48 page 62 |
| Air Filter | Inspect, replace as needed | page 123 |
| Engine intake pre-filter | Inspect, clean | — |
| PVT intake pre-filter | Inspect, clean | — |
| Headlights | Check operation | — |
| Brake lights/taillights | Check operation | — |
| Seat Latches (5 Passenger Models) | Ensure rear seat is secured. | page 58 |

SAFETY

| ITEM | REMARK | REFERENCE |
|--------------------------------|---|-----------|
| Seat Belts | Check length of belt for damage, check latches for proper operation. | page 57 |
| Exhaust | Inspect spark arrester and clean if needed. | page 124 |
| Vehicle Debris | Remove grass, leaves, and other flammable material or debris, especially near the exhaust system. | – |
| Lock adjustable steering wheel | Do not adjust the steering wheel while the vehicle is moving. | – |
| Alternator Belt (if equipped) | Inspect for cracks, damage. Replace, if necessary. | – |

Improper tire maintenance can lead to loss of control and an accident, which could result in serious injury or death. To reduce your risk of injury:

- Maintain POLARIS recommended tire pressure. Check pressure before operating. Even if your vehicle has only been driven a short distance, the tire pressure readings can become higher.
- Make sure tire pressures match the specifications listed in the table below.
- Only use the size and type of tires specified for this vehicle.
- Do not operate your vehicle with worn or damaged tires.
- Always follow your tire manufacturer's instructions for maintenance.

| MEASUREMENT | SPECIFICATION |
|---|---|
| Maximum Cargo Box Load US Models Only | 1000 lbs (454 kg) |
| Maximum Cargo Box Load CA Models Only | 600lbs (272 kg) |
| Tire Pressure in PSI (kPa) NorthStar Edition Trail Boss/Ultimate Models Only | NorthStar Edition Trail Boss/Ultimate Models Front: 10 PSI (69 kPa) Rear: 14 PSI (97 kPa) |

| MEASUREMENT | SPECIFICATION |
|---|--|
| Tire Pressure in PSI (kPa) Crew NorthStar Edition Trail Boss Models Only | Crew NorthStar Edition Trail Boss/Ultimate Models Front: 23 PSI (159 kPa) Rear: 25 PSI (172 kPa) |
| Tire Pressure in PSI (kPa) Premium/NorthStar Premium Models Only | Premium/NorthStar Premium Models Front: 12 PSI (83 kPa) Rear: 14 PSI (97 kPa) |
| Tire Pressure in PSI (kPa) Crew Premium/NorthStar Premium Models Only | Crew Premium/NorthStar Premium Models Front: 18 PSI (124 kPa) Rear: 20 PSI (138 kPa) |
| Tire Pressure in PSI (kPa) Premium/ Ultimate 5 Passenger Models Only | Ultimate Models Front: 18 PSI (124.1 kPa) Rear: 22 PSI (151.7 kPa) |
| Maximum Weight Capacity Includes weight of operator, passenger, cargo, and accessories | NorthStar Edition Trail Boss/Premium/Ultimate US Models 1275 lbs (578 kg) |
| Maximum Weight Capacity Includes weight of operator, passenger, cargo, and accessories | NorthStar Edition Trail Boss/Premium/Ultimate CA Models 1100 lbs (499 kg) |
| Maximum Weight Capacity Includes weight of operator, passenger, cargo, and accessories | Crew NorthStar Trail Boss/Ultimate Models 1150 lbs (522 kg) |
| Maximum Weight Capacity Includes weight of operator, passenger, cargo, and accessories | Premium US Models 1500 lbs (680 kg) |
| Maximum Weight Capacity Includes weight of operator, passenger, cargo, and accessories | Premium CA Models 1100 lbs (499 kg) |
| Maximum Weight Capacity Includes weight of operator, passenger, cargo, and accessories | Crew Premium US Models 1690 lbs (767 kg) |

SAFETY

| MEASUREMENT | SPECIFICATION |
|--|---|
| Maximum Weight Capacity Includes weight of operator, passenger, cargo, and accessories | Crew Premium CA Models 1350 lbs (612 kg) |
| Maximum Weight Capacity Includes weight of operator, passenger, cargo, and accessories | NorthStar Premium Models 1230 lbs (558 kg) |

PREPARE YOURSELF, PASSENGERS, AND CARGO FOR THE RIDE

Wear an approved helmet. Riding in this vehicle without wearing an approved helmet increases the risk of serious injury. For example, a helmet reduces your risk of injury from head strikes with the vehicle or other objects even if there is no crash.

Approved helmets in the USA and Canada bear a U.S. Department of Transportation (DOT) label. Approved helmets in Europe, Asia, and Oceania bear the ECE 22.05 label. The ECE mark consists of a circle surrounding the letter E, followed by the distinguishing number of the country which has granted approval. The approval number and serial number will also be displayed on the label.



Use shatterproof goggles or a shatterproof helmet face shield. Such protective eyewear may reduce the risk of foreign material getting in your eyes and help prevent loss of vision.

POLARIS recommends wearing approved Personal Protective Equipment (PPE) that have markings indicating they are designed to standards such as:

- VESC 8
- V-8
- Z87.1
- CE



Additional protective clothing and gear that may be appropriate for your riding conditions includes:

- Always wear shoes when operating. Consider wearing sturdy over-the-ankle boots suitable for the terrain you will be riding in.
- Full-finger gloves can protect against wind, sun, cold, and objects. Choose gloves that fit snugly and allow fingers to move freely and grip on the steering wheel or hand holds.
- Consider long sleeves and long pants to help protect arms and legs.
- Long-term exposure to wind and engine noise can cause permanent hearing loss. Properly worn hearing protective devices such as earplugs can help prevent hearing loss. Check local laws or the rules of the riding area you are in before wearing hearing protection to make sure its use is permitted.

SAFETY

Always stay completely inside the vehicle and hold the steering wheel or hand holds. Body parts outside of the vehicle can be struck by passing objects or crushed during a rollover. Do not put any part of your body outside of the vehicle for any reason. Do not hold onto the ROPS frame or put any part of your body on the door.

Riding in this vehicle without closed and latched cab doors increases the risk of serious injury or death in the event of an accident or rollover. Always make sure all cab doors are closed and latched while riding in this vehicle.

Be sure riders pay attention and plan ahead. If you think or feel the vehicle may tip or roll, reduce your risk of injury:

- Keep a firm grip on the steering wheel or hand holds and brace yourself.
- Do not put any part of your body outside of the vehicle for any reason.

This vehicle is not designed to carry unrestrained pets. An unrestrained pet can be thrown about and injure riders, even during normal operation. When transporting pets, use a pet crate suitable for off-road use that is secured to the vehicle.

Fuels such as gasoline can be extremely flammable. To reduce the risk of serious injury or death, never carry fuel or other flammable liquids on this vehicle. Rollovers, crashes, rough riding, or changes in elevation or temperature may lead to fuel spilling or vapor release from portable containers. Hot vehicle parts can cause fires, even after the engine has been turned off.

Never exceed vehicle weight capacities. The vehicle's maximum weight capacity (including riders, cargo, and accessories) is 740 lbs. (336 kg) total. The cargo box can support up to 600 bs. (272 kg) of that total. When more rider weight is added, cargo weight may need to be eliminated to stay under the 740 lb. (336 kg) limit. Overloading the vehicle or carrying cargo improperly will cause changes in stability and handling, which could cause loss of control or an accident.

Secure cargo in the cargo box as far forward, centered and as low as possible. When cargo cannot be positioned and secured in this way, operate with extra caution. Unsecured cargo can strike and injure riders, affect vehicle handling, and result in loss of control.

The weight of riders and cargo changes vehicle braking, handling, and stability. To avoid loss of control, turn gradually, operate at slower speeds, and avoid rougher or steeper terrain.

DRIVING GUIDELINES

Drive Responsibly. This vehicle has higher ground clearance and other features to handle rugged terrain. It can be overturned in situations where some other vehicles may not. Abrupt maneuvers or aggressive driving, even on flat, open areas, can cause loss of control, rollovers, severe injury or death. To avoid loss of control and rollovers:



- Avoid abrupt maneuvers, sideways sliding, skidding, or fishtailing, and never do donuts.
- Slow down before entering turn.
- Avoid hard acceleration when turning, even from a stop.

High speed off-road operation

Driving off-road vehicles to test the limits of your skills or abilities can be very dangerous to you, passengers, and bystanders. Basic skills for driving a car, ATV, or other off-road vehicles do not equip drivers to safely attempt high speed off-road operation. Develop your skill gradually through training, practice, and experience with the various driving modes of this vehicle and the terrain in which you are operating. Always do a low speed reconnaissance run (prerun) to become aware of anything you may encounter.

High speed off-road operation can lead to loss of control, crashes, or hard landings that can seriously injure occupants (even without rolling the vehicle or damaging it).

If you plan on using the vehicle for high speed, off-road competition, additional safety equipment may be necessary. Check the rules that apply to your competition.

Do not go over jumps — going airborne can lead to serious injury or death.

Going airborne can cause loss of control, rollovers, or crashing into the ground and may damage the vehicle. Even without crashing, landings can be hard enough to cause any vehicle suspension to fully compress (e.g., bottom out). Serious injuries, including spinal injuries, can occur even if riders are properly harnessed, wearing helmets and the vehicle is not damaged and remains upright.

You may encounter slopes, "jumps", or other terrain features that could send the vehicle airborne, depending on your speed. These may be defectively designed, poorly maintained, or not suitable for this vehicle. Slow down, use extra care, and avoid going airborne. Never take this vehicle over jumps.

SAFETY

Watching someone else go over a jump or go airborne does not mean you can safely do so. Polaris cannot determine whether any jump you may encounter is appropriate for this vehicle. Any jump, even a small one, could be poorly maintained, designed, or not suitable for this vehicle and may cause serious injury or death.



Plan for hills, rough terrain, ruts, and other changes in traction and terrain.

Proceed slowly and with extra care on unfamiliar terrain. Avoid paved surfaces. Sudden changes in terrain such as holes, depressions, banks, softer or harder ground, or other irregularities may cause loss of control or rollover. Give yourself time to react to rocks, bumps, or holes that may be hard to see. Operating in deep snow or tall grass may make it harder to see obstacles.

If you cannot go around an obstacle, such as a fallen tree or a ditch, stop the vehicle in a safe place. Get out to inspect the area thoroughly. Look from both your approach side and exit side. If you are reasonably confident you can continue safely, choose the path that will allow you to go straight over the obstacle to minimize the vehicle tipping sideways. Go only fast enough to maintain your momentum, but still give yourself plenty of time to react to changes in conditions. If there is any question about your ability to maneuver safely over the obstacle, you should turn around if the ground is flat and you have the room, or back up until you find a less difficult path.

Abrupt application of the accelerator pedal can cause the tires to lose traction, reducing control of the vehicle and increasing the possibility of an accident, especially while on sloped terrain or while crossing obstacles such as rocks or logs.

Avoid Operating on Public Roads (Paved or Otherwise). This vehicle does not have highway safety features that on-road vehicles may have (air bags, anti-lock brakes, stability control, etc.). If another vehicle collides with you, the likelihood of a serious injury or death may be greater. Also, you may not be able to avoid a crash or rollover if you make sudden or abrupt maneuvers such as swerving or emergency braking.

While it may be legal to drive on some public roads, it is recommended that you avoid on-road operation. If you must drive on-road, drive slowly and defensively. Use extra care. You may also need to make vehicle modifications to comply with state or local laws. In addition, refer to tire manufacturer's instructions or limitations for on-road operation, including speed limits and premature tire wear.

Improperly operating on hills can cause loss of control, rollover, or accident, which can lead to serious injury or death. Use extra care when operating on hills. Plan for rough terrain, ruts, and other changes in traction and terrain.

Driving up hills

Check the terrain before ascending a hill and make sure it is not too slippery or loose. Engage all-wheel drive for hills. Drive straight uphill, keeping speed and throttle steady. Avoid steep hills which can cause the vehicle to overturn.

Recovering from stalling on a hill

If the vehicle loses forward speed, apply the brakes gradually and stop. Do not attempt to turn the vehicle around. Instead, shift to reverse and allow the vehicle to slowly roll straight downhill. Apply light brake pressure to control speed.

Overtopping a hill

Slow down when you reach the crest of a hill. Never blindly go over the crest of a hill or a drop off at high speed. An obstacle, a sharp drop, or another vehicle or person could be on the other side of the hill.

Driving down hills

Check the terrain before descending a hill and make sure it is not too slippery or loose. Engage all-wheel drive and proceed slowly, applying the brakes lightly. Never descend a hill with the transmission in neutral or if the engine is turned off.

Avoid side hilling (riding across slopes)

If unavoidable, proceed slowly and with extra caution. Avoid obstacles and changes in terrain that could cause the vehicle to tip or slide. If it feels like the vehicle begins to tip or slide, immediately turn downhill.

Riding near wooded areas or brush

Use extra caution when operating near trees, particularly when operating on narrow trails. Tree branches or brush can be driven into the cab striking or stabbing occupants.



Riding in snow

Always keep the brake and accelerator pedals free of snow and ice. Apply the brakes frequently to prevent ice or snow accumulation on the brake pads which can reduce brake performance.

Riding on ice

Never operate the vehicle on a frozen body of water unless you have verified that the ice can support the weight of the vehicle. Severe injury or death can result if the vehicle falls through the ice.

SAFETY

Riding in water / Falling into water

Operating through deep or fast-flowing water can cause loss of traction, loss of control, overturning, or being swept away in water. You can be seriously injured or killed from entrapment and drowning. Never operate the vehicle in fast-flowing water or in water that exceeds the floor level of the vehicle. Avoid sharp drop-offs and large rocks. Choose a path that provides an entrance and exit point with gradual inclines. Wet brakes may have reduced stopping ability. After leaving water, test the brakes. Apply them lightly several times while driving slowly. The friction will help dry out the pads.

Riding on sand dunes

Use extra caution when operating on or near dunes. Be alert for changes in terrain. Never blindly go over the crest of a hill or a drop-off at high speed. An obstacle, a sharp drop, or another vehicle or a person could be on the other side of the hill.

Riding in low-visibility conditions

Use extra caution and drive slowly in conditions of reduced visibility such as fog, rain, and darkness.

Plan ahead to avoid the need for evasive maneuvers, such as swerving.

Hitting an obstacle — including wildlife — you are not ready for can be dangerous. Choosing to swerve instead can be even more dangerous because it can lead to loss of control, rollover, or collisions.

When operating in areas with possibility of wildlife appearing in your path, plan ahead to avoid swerving for animals if doing so could result in collisions or rollovers. Go slowly or avoid driving during seasons or times of day when animals such as deer are more likely to cross your path without warning.

Avoid Collisions With Other Vehicles

When following another vehicle or operating in the same area as others, keep a safe distance to avoid collisions. Allow extra space when sight distances are limited by dust, snow, curves, hills, or other conditions. Plan ahead to avoid having to swerve or leave the trail to avoid a collision.

On trails, be prepared to make space for other vehicles to pass. If you need to stop on a trail, move your vehicle to the edge of the path to allow others to pass safely.

Correct a skid by turning the steering wheel in the direction of the skid.

Never apply the brakes during a skid.

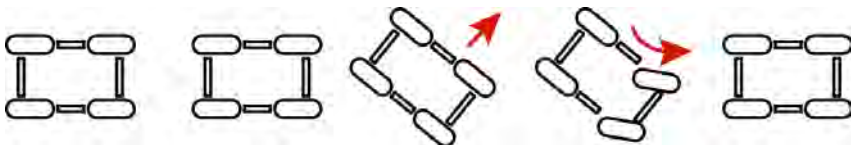

If the vehicle begins to slide downhill or you feel it may tip, turn downhill immediately and stop. Maneuver slowly and carefully until you can drive straight downhill.

Do not continue driving if your vehicle may be damaged or if you were in a crash or rollover.

Operating the vehicle while damaged or after a crash or rollover can cause loss of control, rollover, or accident, which can lead to serious injury or death. If you cannot safely transport the vehicle on your own, contact a recovery and towing service.

After any crash, rollover, or other accident, have a POLARIS dealer inspect the vehicle for possible damage, including seat belts, ROPS, brakes, suspension, and steering systems.

Be prepared in case your vehicle becomes damaged or disabled, especially in remote areas. Consider in advance how to get help and stay safe until it arrives whenever you ride.

SAFETY

There is a recovery tow loop ① at the front and back of the vehicle to attach a winch or strap.

Use these loops to recover this vehicle if it is stuck, to pull it onto a tow truck, trailer, or to use this vehicle to recover another vehicle. These loops are for emergency recovery only and are not for towing vehicles to another location.

Improper recovery may lead to loss of control or vehicle damage. Only attach straps to specified locations. Do not attach to any other point on the vehicle. Only recover a vehicle of equal or lesser size and weight. When recovering a disabled vehicle, place the disabled vehicle's transmission in neutral. Do not move a disabled POLARIS XPEDITION faster than 10 mph (16 km/h).

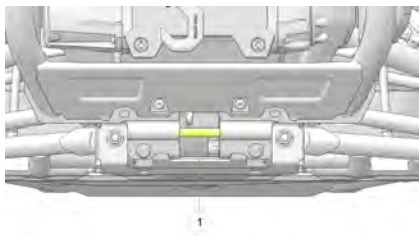

Operating, Idling, Or Parking Near Combustible Materials

Engine, exhaust, and other vehicle components can be very hot during and after use. Do not idle or park the vehicle over anything that could contact the exhaust system and catch on fire, such as tall grass, weeds, brush, leaves, debris, or other tall ground cover. Do not let mud, grass, or other debris accumulate on the engine or exhaust system. Inspect and remove as needed.

Vehicle rollaway can cause serious injury or death. This vehicle can roll whenever the gear selector is not in the PARK (P) position. Always shift to PARK (P) when stopping the engine or leaving the vehicle. When leaving the vehicle on an incline is unavoidable, use extra care. If leaving the vehicle unattended, block the rear wheels on the downhill side and keep children, pets, and others away from the gear selector.

Before shifting into reverse, use extra care to make sure the area is clear of people or obstacles. When it's safe to proceed, back slowly.

After operation, inspect the vehicle for damage and debris to make sure the vehicle can be safely stored and operated again. Some things to inspect include:

- Debris that could catch fire, such as mud/grass near the engine or exhaust system
- Damage to the suspension, steering, or any other part of the vehicle
- Tire condition, such as tread and sidewall damage
- Shock absorber assembly condition

Be sure to have any issues checked and problems fixed before operating again.

All engine exhaust contains carbon monoxide, a deadly gas. Breathing carbon monoxide can cause headaches, dizziness, drowsiness, nausea, confusion, and eventually death. Carbon monoxide is a colorless, odorless, tasteless gas which may be present even if you do not see or smell any engine exhaust. Deadly levels of carbon monoxide can collect rapidly, and you can quickly be overcome and unable to save yourself. Also, deadly levels of carbon monoxide can linger for hours or days in enclosed or poorly ventilated areas. If you experience any symptoms of carbon monoxide poisoning, leave the area immediately, get fresh air, and **SEEK MEDICAL TREATMENT**.

- Do not run engine indoors. Even if you try to ventilate engine exhaust with fans or open windows and doors, carbon monoxide can rapidly reach dangerous levels.
- Do not run engine in poorly ventilated or partially enclosed areas such as barns, garages, or carports. If you start a vehicle in one of these, drive it out and close the door as soon as possible. If you drive it into one of these, turn it off as soon as possible.
- Do not run engine outdoors where engine exhaust can be drawn into a building through openings such as windows and doors.

SAFETY LABELS AND LOCATIONS

Warning labels have been placed on the vehicle for your protection. Read and follow the instructions of the labels on the vehicle carefully. If any of the labels depicted in this manual differ from the labels on your vehicle, always read and follow the instructions of the labels on the *vehicle*.

If an informational or graphic label becomes illegible or comes off, contact your POLARIS dealer to obtain a replacement. Replacement *safety* labels are provided by POLARIS at no charge. The part number is printed on the label.

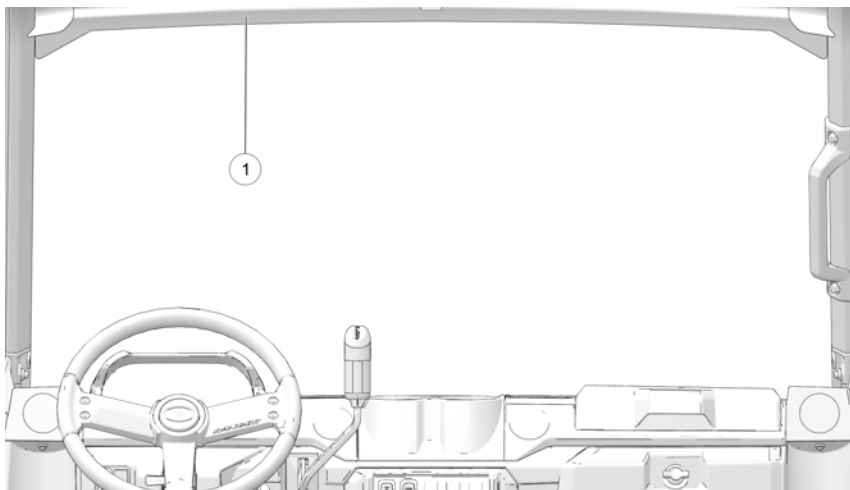

The safety labels ① are located on the front ROPS, above the driver's head.

SEAT BELT / DRIVER WARNING

WARNING

Improper vehicle use can result in SEVERE INJURY or DEATH

Be Prepared

- Fasten seat belt.
- Wear an approved helmet and protective gear.
- ALWAYS use vehicle cab nets and/or doors.
- Each rider must be able to sit with back against seat, feet flat on the floor, and hands on steering wheel or handholds. Stay completely inside the vehicle.

Drive Responsibly

Avoid loss of control and rollovers:

- Avoid abrupt maneuvers, sideways sliding, skidding or fishtailing, and never do donuts.
- Slow down before entering a turn.
- Avoid hard acceleration when turning, even from a stop.
- Plan for hills, rough terrain, ruts and other changes in traction and terrain. Avoid paved surfaces.
- Avoid side-hilling (riding across slopes).

Be Sure Riders Pay Attention and Plan Ahead

If you think or feel the vehicle may tip or roll, reduce your risk of injury:

- Keep a firm grip on the steering wheel or handholds and brace yourself.
- Do not put any part of your body outside of the vehicle for any reason.

Rollovers have caused severe injuries and death, even on flat, open areas.

SAFETY

PROPER USE WARNING

3-SEAT MODELS

WARNING

Require Proper Use of Your Vehicle

Do your part to prevent injuries:

- Do not allow careless or reckless driving.
- Make sure operators are 16 or older with a valid driver's license.
- Do not let people drive or ride after using alcohol or drugs.
- Do not allow operation on public roads (unless designated for off-highway vehicle access) - collisions with cars and trucks can occur.
- Do not exceed seating capacity: 3 occupants.

CREW MODELS

WARNING

Improper Vehicle Use Can Result in SEVERE INJURY or DEATH

Be sure riders pay attention and plan ahead.

If you think the vehicle may tip or roll, reduce your risk to injury:

- Keep a firm grip on the steering wheel or handholds and brace yourself.
- Do not put any part of your body outside of the vehicle for any reason.

Require Proper Use of Your Vehicle.

Do your part to prevent injuries:

- Do not allow careless or reckless driving.
- Make sure operators are 16 or older with a valid driver's license.
- Do not let people drive or ride after using alcohol or drugs.
- Do not allow operation on public roads (unless designated for off-highway vehicle access) – collisions with cars and trucks can occur.

Do not exceed seating capacity: 6 occupants.

PAYLOAD WARNING/SHIFT CAUTION

Premium, CREW Premium, CREW Texas Edition, Northstar Edition Premium, and CREW Northstar Edition Premium models only

| RANGER | NEVER EXCEED | IF TOTAL PAYLOAD EXCEEDS |
|-----------------|-----------------|--------------------------|
| BASE 1000 | 40 mph (64 kph) | 550 lbs. (250 kg) |
| XP 1000 | 40 mph (64 kph) | 550 lbs. (250 kg) |
| CA XP 1000 | 40 mph (64 kph) | 550 lbs. (250 kg) |
| BASE CREW | 40 mph (64 kph) | 970 lbs. (440 kg) |
| CREW XP 1000 | 43 mph (69 kph) | 980 lbs. (445 kg) |
| CA CREW XP 1000 | 43 mph (69 kph) | 980 lbs. (445 kg) |

CAUTION

To avoid transmission damage, shift only when vehicle is stationary and at idle. When vehicle is stopped, place shift in parked position.

Northstar Edition Ultimate, CREW Northstar Edition Ultimate, Northstar Edition Ultimate Trail Boss, and CREW Northstar Edition Ultimate Trail Boss models only.

| RANGER | NEVER EXCEED | IF TOTAL PAYLOAD EXCEEDS |
|---------------------------|-----------------|--------------------------|
| XP 1000 ULT/TB/RC | 40 mph (64 kph) | 550 lbs. (250 kg) |
| XP 1000 ULT/TB/RC CREW | 43 mph (69 kph) | 980 lbs. (445 kg) |

CAUTION

To avoid transmission damage, shift only when vehicle is stationary and at idle. When vehicle is stopped, place shift in parked position.

SAFETY

FUEL TRANSPORT WARNING

The Fuel Transport Warning label is located in the cargo box.

WARNING

NEVER carry fuel or other flammable liquids on this vehicle

Failure to follow this instruction could lead to serious burn injuries or death.

Part number: 7186122 (English),
7186122-F (French Canadian)



CLUTCH COVER WARNING

WARNING

The Clutch Cover Warning ① is located on the clutch cover.

- Improper service or maintenance of this PVT system can result in vehicle damage, SEVERE INJURY or DEATH.
- Always look for and remove debris inside and around clutch and vent system when replacing belt.
- Read owner's manual or see authorized Polaris dealer.

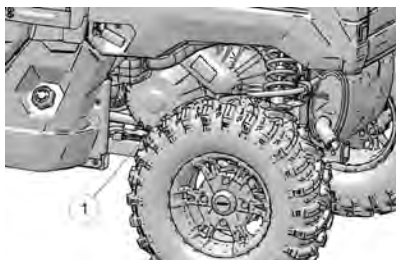

AIR BOX CAUTION

CAUTION

Use a Polaris approved air filter. The use of a non-Polaris approved air filter may cause engine damage. Before installing filter, ensure there is no dirt or debris in the clean side of the intake tube. The air filter must be properly seated before the lid is reinstalled. Please reference your owner's manual for additional information regarding air filter service.

LOAD/PASSENGER/TIRE PRESSURE WARNING

The Load/Passenger/Tire Pressure Warning ① is located in the cargo box.

WARNING

- Never carry passengers in cargo box.
- Passengers can be thrown off. This can cause serious injury or death.
- If total payload is greater than 500 lbs, the vehicle must be operated in LOW range.

WARNING

IMPROPER TIRE PRESSURE OR OVERLOADING CAN CAUSE LOSS OF CONTROL RESULTING IN SERIOUS INJURY OR DEATH.

- Reduce speed and allow greater distance for braking when carrying cargo.
- Overloading or carrying tall, off-center, or unsecured loads will increase your risk of losing control. Loads should be centered and carried as low as possible in box.
- For stability on rough or hilly terrain, reduce speed and cargo.

RANGER XP 1000 NorthStar Edition Trail Boss Models

| RANGER | XP 1000 HVAC | CA XP 1000 HVAC |
|---|-------------------------------|-------------------------------|
| MAXIMUM CARGO BOX LOAD | 1000 lbs. (454 kg) | 600 lbs. (272 kg) |
| TIRE PRESSURE IN PSI (KPa) | FRONT 10 (69) REAR 14 (97) | FRONT 10 (69) REAR 14 (97) |
| MAXIMUM WEIGHT CAPACITY INCLUDES WEIGHT OF OPERATOR, PASSENGER, CARGO, AND ACCESSORIES. | 1275 lbs. (578 kg) | 1100 lbs. (499 kg) |

Read Operation & Maintenance Manual for more detailed loading information.

SAFETY

RANGER CREW XP 1000 NorthStar Edition Trail Boss Models

| RANGER | XP CREW HVAC | CA XP CREW HVAC |
|---|---------------------------------|---------------------------------|
| MAXIMUM CARGO BOX LOAD | 1000 lbs. (454 kg) | 600 lbs. (272 kg) |
| TIRE PRESSURE IN PSI (KPa) | FRONT 23 (159) REAR 25 (172) | FRONT 23 (159) REAR 25 (172) |
| MAXIMUM WEIGHT CAPACITY INCLUDES WEIGHT OF OPERATOR, PASSENGER, CARGO, AND ACCESSORIES. | 1150 lbs. (522 kg) | |
| Read Operation & Maintenance Manual for more detailed loading information. | | |

RANGER XP 1000 NorthStar Edition Ultimate Models

| RANGER | XP 1000 HVAC | CA XP 1000 HVAC |
|---|-------------------------------|-------------------------------|
| MAXIMUM CARGO BOX LOAD | 1000 lbs. (454 kg) | 600 lbs. (272 kg) |
| TIRE PRESSURE IN PSI (KPa) | FRONT 10 (69) REAR 14 (97) | FRONT 10 (69) REAR 14 (97) |
| MAXIMUM WEIGHT CAPACITY INCLUDES WEIGHT OF OPERATOR, PASSENGER, CARGO, AND ACCESSORIES. | 1275 lbs. (579 kg) | 1100 lbs. (499 kg) |
| Read Operation & Maintenance Manual for more detailed loading information. | | |

RANGER CREW XP 1000 NorthStar Edition Ultimate Models

| RANGER | XP CREW HVAC | CA XP CREW HVAC |
|---|---------------------------------|---------------------------------|
| MAXIMUM CARGO BOX LOAD | 1000 lbs. (454 kg) | 600 lbs. (272 kg) |
| TIRE PRESSURE IN PSI (KPa) | FRONT 23 (159) REAR 25 (172) | FRONT 23 (159) REAR 25 (172) |
| MAXIMUM WEIGHT CAPACITY INCLUDES WEIGHT OF OPERATOR, PASSENGER, CARGO, AND ACCESSORIES. | 1150 lbs. (522 kg) | |
| Read Operation & Maintenance Manual for more detailed loading information. | | |

RANGER XP 1000 Premium Models

| RANGER | XP 1000 | CA XP 1000 |
|---|-------------------------------|-------------------------------|
| MAXIMUM CARGO BOX LOAD | 1000 lbs. (454 kg) | 600 lbs. (272 kg) |
| TIRE PRESSURE IN PSI (KPa) | FRONT 12 (83) REAR 14 (97) | FRONT 12 (83) REAR 14 (97) |
| MAXIMUM WEIGHT CAPACITY INCLUDES WEIGHT OF OPERATOR, PASSENGER, CARGO, AND ACCESSORIES. | 1500 lbs. (680 kg) | 1100 lbs. (499 kg) |
| Read Operation & Maintenance Manual for more detailed loading information. | | |

SAFETY

RANGER CREW XP 1000 Premium Models

| RANGER | XP 1000 CREW | CA XP 1000 CREW |
|---|---------------------------------|---------------------------------|
| MAXIMUM CARGO BOX LOAD | 1000 lbs. (454 kg) | 600 lbs. (272 kg) |
| TIRE PRESSURE IN PSI (KPa) | FRONT 18 (124) REAR 20 (138) | FRONT 18 (124) REAR 20 (138) |
| MAXIMUM WEIGHT CAPACITY INCLUDES WEIGHT OF OPERATOR, PASSENGER, CARGO, AND ACCESSORIES. | 1690 lbs. (767 kg) | 1350 lbs. (612 kg) |
| Read Operation & Maintenance Manual for more detailed loading information. | | |

RANGER XP 1000 NorthStar Premium Models

| RANGER | XP 1000 HVAC | CA XP 1000 HVAC |
|---|-------------------------------|-------------------------------|
| MAXIMUM CARGO BOX LOAD | 1000 lbs. (454 kg) | 600 lbs. (272 kg) |
| TIRE PRESSURE IN PSI (KPa) | FRONT 12 (83) REAR 14 (97) | FRONT 12 (83) REAR 14 (97) |
| MAXIMUM WEIGHT CAPACITY INCLUDES WEIGHT OF OPERATOR, PASSENGER, CARGO, AND ACCESSORIES. | 1275 lbs. (578 kg) | 1100 lbs. (499 kg) |
| Read Operation & Maintenance Manual for more detailed loading information. | | |

RANGER CREW XP 1000 NorthStar Premium Models

| RANGER | XP CREW HVAC | CA XP CREW HVAC |
|---|---------------------------------|---------------------------------|
| MAXIMUM CARGO BOX LOAD | 1000 lbs. (454 kg) | 600 lbs. (272 kg) |
| TIRE PRESSURE IN PSI (KPa) | FRONT 18 (124) REAR 20 (138) | FRONT 18 (124) REAR 20 (138) |
| MAXIMUM WEIGHT CAPACITY INCLUDES WEIGHT OF OPERATOR, PASSENGER, CARGO, AND ACCESSORIES. | 1230 lbs. (558 kg) | |
| Read Operation & Maintenance Manual for more detailed loading information. | | |

RANGER XP 1000 Texas Edition Models

| RANGER | XP 1000 HVAC |
|---|--------------------------------|
| MAXIMUM CARGO BOX LOAD | 1000 lbs. (454 kg) |
| TIRE PRESSURE IN PSI (KPa) | FRONT 14 (97) REAR 16 (110) |
| MAXIMUM WEIGHT CAPACITY INCLUDES WEIGHT OF OPERATOR, PASSENGER, CARGO, AND ACCESSORIES. | 1600 lbs. (726 kg) |
| Read Operation & Maintenance Manual for more detailed loading information. | |

INTERNATIONAL SAFETY LABELS

GENERAL ALERT



⚠ WARNING

Read your owner's manual. Never allow anyone under 16 years of age to operate this vehicle. Never use alcohol or drugs before or while driving or riding. Do not allow operation on public roads (unless designated for off-highway vehicle access). Wear approved helmet, goggles, and protective clothing. Always wear seat belts. Always use the cab nets or doors. Never exceed seating capacity.

CLUTCH COVER ALERT

⚠ WARNING

Keep body parts away from belt.



SHIFT ALERT

⚠ WARNING

To avoid transmission damage, shift only when vehicle is stationary and at idle. APPLY BRAKE TO START. When this vehicle is not in operation, or unattended, place shift in the park position.

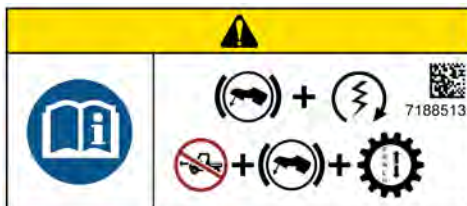

INTAKE ALERT

⚠ WARNING

Use a Polaris approved air filter. The use of a non-Polaris approved air filter may cause engine damage. Before installing filter ensure there is no dirt or debris in the clean side of the intake tube.

The air filter must be properly seated and the hinges fully inserted when the lid is reinstalled. Please reference your owner's manual for additional information regarding the air filter service.



Label Location: on the air box.

HITCH CAPACITY ALERT

⚠ WARNING

MAXIMUM DRAWBAR PULL:
11120 N on level ground
MAXIMUM VERTICAL LOAD:
1117 N













SAFETY

HD MODELS ONLY

LOAD/PASSENGER/TIRE PRESSURE WARNING

WARNING





















Never carry passengers in cargo box. Passengers can be thrown off. This can cause serious injury or death. Read owner's manual. Never carry or transport fuel on this vehicle.

| | | |
|--|---|---|
|  | | |
|  |  |  |
| RANGER XP | | |
|  < 454 kg | | |
|  69 kPa/ 0,69 bar |  96 kPa/ 0,96 bar | |
|  +  < 680 kg | |  |

| VEHICLE | MAXIMUM CARGO BOX LOAD | TIRE PRESSURE IN KPA/BAR | MAXIMUM CAPACITY |
|-----------|------------------------|---|---|
| RANGER XP | 454 kg | Front: 69 kPa/0,69 bar Rear: 96 kPa/0,96 bar | Occupants: 3 Weight (Driver + Passengers + Tow Load): 680 kg |

MD MODELS ONLY**LOAD/PASSENGER/TIRE PRESSURE ALERT**

Never carry passengers in cargo box. Passengers can be thrown off. This can cause serious injury or death. Read owner's manual. NEVER carry fuel or other flammable liquids on this vehicle. Failure to follow this instruction could lead to serious burn injuries or death.

|  | | |
|---|---|---|
|  |  |  |
| RANGER TR | | |
|  < 454 kg | | |
|  69 kPa/ 0,69 bar 10 PSI |  | 97 kPa/ 0,97 bar 14 PSI |
|  69 kPa/ 0,69 bar 10 PSI |  | 170 kPa/ 1,7 bar 24,6 PSI |
| RANGER EU/ZUG | | |
|  < 454 kg | | |
|  69 kPa/ 0,69 bar 10 PSI |  | 97 kPa/ 0,97 bar 14 PSI |
|  69 kPa/ 0,69 bar 10 PSI |  | 210 kPa/ 2,1 bar 30,5 PSI |
| RANGER CREW, EU | | |
|  < 454 kg | | |
|  96 kPa/ 0,96 bar 14 PSI |  | 110 kPa/ 1,10 bar 16 PSI |
|  96 kPa/ 0,96 bar 14 PSI |  | 210 kPa/ 2,1 bar 30,5 PSI |
|  7300424 | | |

| | |
|--|------------------------------------|
| RANGER CREW MD | |
| MAXIMUM CARGO BOX LOAD | 454 kg |
| TIRE PRESSURE IN kPa (bar) | FRONT 96 (0,96) REAR 110 (1,10) |
| Read Operation and Maintenance Manual for more detailed loading information. | |

FEATURES AND CONTROLS

COMPONENT LOCATIONS

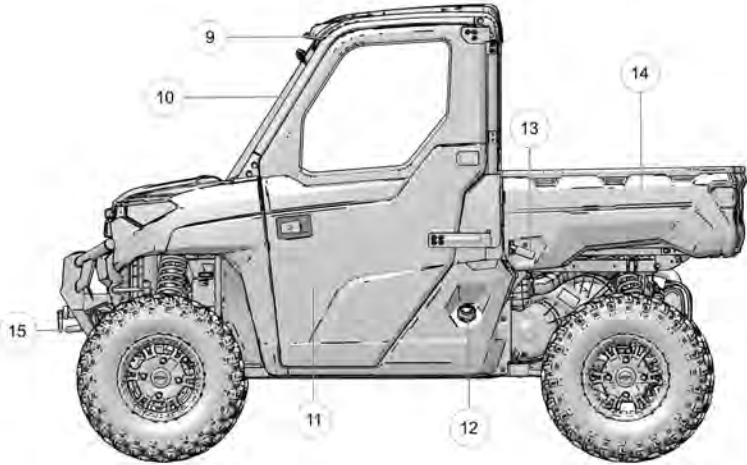

- ① Console
- ② Headlights
- ③ Radiator/AC Condenser
- ④ Bumper/Brush Guard
- ⑤ Tailgate
- ⑥ Taillights
- ⑦ Wheel/Tire
- ⑧ Receiver Hitch
- ⑨ ROPS Cab Frame
- ⑩ Windshield (if equipped)
- ⑪ Door (if equipped)
- ⑫ Fuel Cap
- ⑬ Cargo Box Release Lever
- ⑭ Cargo Box
- ⑮ Winch (if equipped)

FEATURES AND CONTROLS

COMPONENT LOCATIONS

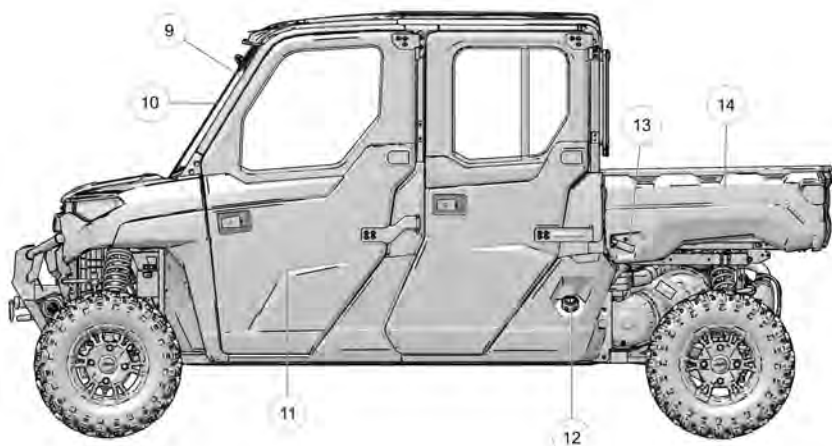

- | | |
|-------------------------|---------------------------|
| ① Console | ⑧ Receiver Hitch |
| ② Headlights | ⑨ ROPS Cab Frame |
| ③ Radiator/AC Condenser | ⑩ Windshield |
| ④ Bumper/Brush Guard | ⑪ Door |
| ⑤ Tailgate | ⑫ Fuel Cap |
| ⑥ Taillights | ⑬ Cargo Box Release Lever |
| ⑦ Wheel/Tire | ⑭ Cargo Box |

CONSOLE

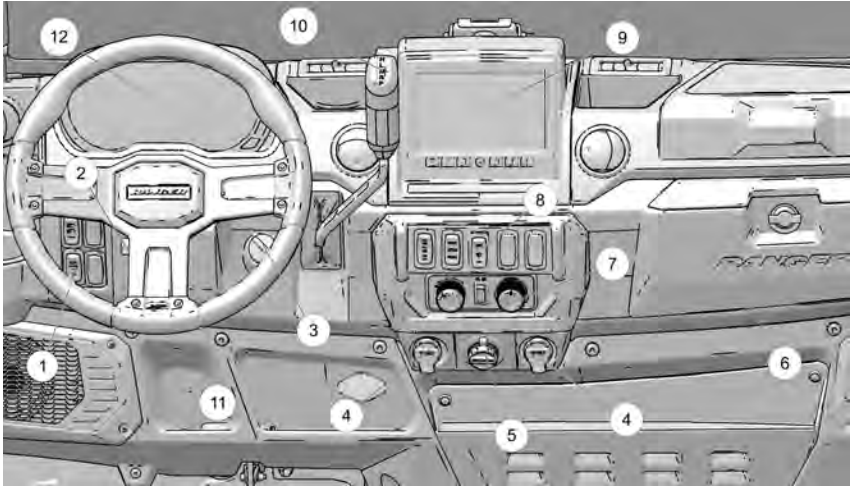

- | | |
|---|--------------------------------------|
| ① Left-Side Switch Panel | ⑦ HVAC Control Panel (if equipped) |
| ② Steering Wheel Adjuster | ⑧ Right-Side Switch Panel |
| ③ Ignition | ⑨ Ride Command Display (if equipped) |
| ④ 12V Auxiliary Outlets | ⑩ Gear Selector (Shifter) |
| ⑤ Battery Trickle Charging Outlet | ⑪ Steering Wheel |
| ⑥ Winch Remote (underneath hood, if equipped) | ⑫ Instrument Cluster |

FEATURES AND CONTROLS

IGNITION SWITCH

The ignition switch^① is a four-position, key-operated switch. The key can be removed from the switch when it is in the OFF position.

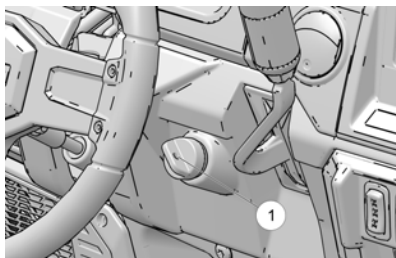

| | |
|-----------|---|
| OFF | The engine is off. Electrical circuits are off. |
| ACCESSORY | The engine is off. Powers the gauge and terminal block. Check engine and steering warning indicators will appear on the gauge in this mode, but will turn off when the vehicle is started if no issues are present. |
| SYSTEM ON | Electrical circuits and position lights are on. Electrical equipment can be used. |
| START | Turn the key to the START position to engage the electric starter. The key returns to the ON position when released. |

Ignition Switch Label (MD and HD models only)

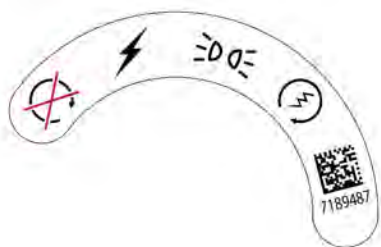

STEERING WHEEL

The steering wheel can be tilted upward or downward for rider preference. Lift and hold the steering wheel adjustment lever ① while moving the steering wheel upward or downward. Release the lever when the steering wheel is at the desired position. Always make sure the steering wheel position does not impede proper operation of the brake pedal, throttle pedal and all other controls.

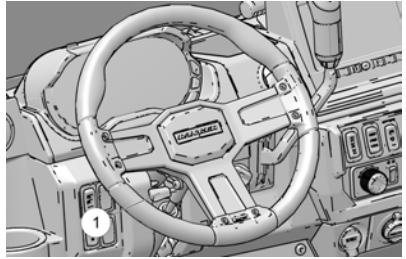

GEAR SELECTOR

To change gears, stop the vehicle, and with the engine idling, move the lever ① to the desired gear. Do not attempt to shift gears with engine speed above idle or while the vehicle is moving.

- H: High Gear
- L: Low Gear
- N: Neutral
- R: Reverse
- P: Park

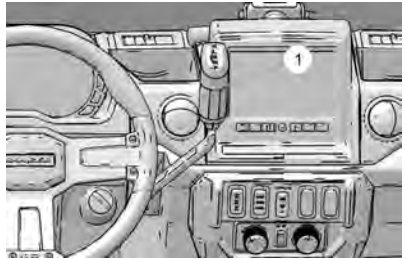

Low gear is the primary driving range for the RANGER. High gear is intended for use on hard-packed surfaces with light loads. Whenever the vehicle is left unattended, always place the transmission in PARK.

TIP

Maintaining shift linkage adjustment is important to assure proper transmission function. Your POLARIS dealer or other qualified person can assist in resolving any shifting problems.

NOTICE

Do not attempt to shift the transmission while the vehicle is moving or damage to the transmission could result. Always shift when the vehicle is stationary and the engine is at idle.

FEATURES AND CONTROLS

SWITCHES

Not all switches are present on every model.

LIGHT SWITCH

The ignition switch key must be in the ON/RUN position to operate the headlights. Press the top of the rocker switch toward the dash to place the headlights on high beam. Move the rocker switch to the center position to place the headlights on low beam. Press the bottom of the rocker switch to turn off the headlights.



AWD SWITCH

The AWD switch has three positions: All Wheel Drive (AWD), Differential Lock/Two Wheel Drive (2WD) and Off (1WD / Turf Mode).

Press the top of the switch to engage All Wheel Drive (AWD).

Move the switch to the center position to lock the differential and operate in two wheel drive (2WD).

Press the bottom of the switch to unlock the differential and allow the rear drive wheels to operate independently (1WD / Turf Mode).

This mode of operation is well suited to turf driving or when active traction is not needed.



POLARIS 3-MODE THROTTLE CONTROL SWITCH

The Polaris 3-Mode Throttle Control Switch has three positions:

- Performance (PERF)
- Standard (STND)
- Work (WORK)

Always use low gear for any of the following conditions regardless of the selected throttle control setting:

- Operating in rough terrain or over obstacles.
- Loading the vehicle onto a trailer.
- Towing heavy loads.
- Driving frequently at low RPM or at ground speeds below 7 MPH (11 km/h).



ACTIVE DESCENT CONTROL (ADC) SWITCH (IF EQUIPPED)

The ADC system allows engine braking to all four wheels when the vehicle descends a hill or incline. Press the top of the switch to engage ADC. Press the bottom of the switch to turn off ADC. Always operate in low gear and engage ADC before ascending or descending a hill.



HVAC CONTROL PANEL (IF EQUIPPED)

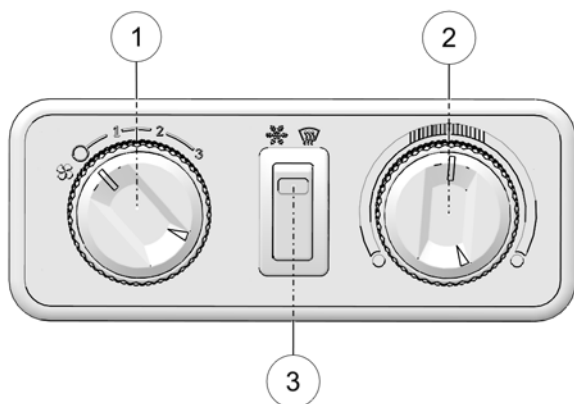

To operate the cab heater, rotate the fan control ① to the desired fan speed setting. The far left setting turns the fan off.

Adjust the temperature by rotating the temperature control ② to the desired heat setting. Rotate the control clockwise to increase heat or counter-clockwise to decrease heat.

Press the top of the A/C switch ③ to enable the air conditioning system for cooling or defrost purposes.

WINDSHIELD WIPER/WASHER SWITCH (IF EQUIPPED)

The windshield wiper/washer switch is located on the vehicle dashboard. The windshield washer fluid reservoir is located under the hood.

Select the desired function by pressing the top or bottom of the switch. The windshield wiper/washer switch has three positions:

- WASHER ON - top of switch fully pressed
- WIPER ON - middle position
- OFF - bottom of switch fully pressed



WINCH CONTROLS (IF EQUIPPED)

NOTE

Vehicles equipped with factory-installed winches have an automatic stop function to prevent overtightening when the winch is fully wound.

WINCH SWITCH

Press the top of the rocker switch to spool line out from the winch. Press the bottom of the rocker switch to spool line in to the winch. Move the rocker switch to the center position to stop spooling.



REMOTE WINCH SWITCH (IF EQUIPPED)

The remote winch switch is located under the hood. To power-on or power-off the switch, press and hold the power button for 3 seconds. Press and hold the button labeled "OUT" to spool line out from the winch. Press and hold the button labeled "IN" to spool line in to the winch. The switch will automatically power-off after 30 seconds of inactivity.



FEATURES AND CONTROLS

AUXILIARY OUTLET

The vehicle is equipped with 12-volt accessory outlets on the dash. Use the outlets to power an auxiliary light or other optional accessories or lights. For service, the dash outlet connection is under the dash.



BATTERY TRICKLE-CHARGING OUTLET

The vehicle is equipped with a dedicated outlet for trickle-charging the battery during periods of extended inactivity.

If you do not drive the vehicle for more than TWO WEEKS, Polaris recommends using a BatteryMINDER® 2012 AGM - 2 AMP charger, which can be ordered through your dealer.

Polaris provides a charging accessory with your vehicle that allows easy connection to the battery through the Battery Trickle-Charging Outlet, located on the dash. While charging, place the charger outside of the vehicle and protect it from moisture.



FOOT PEDALS

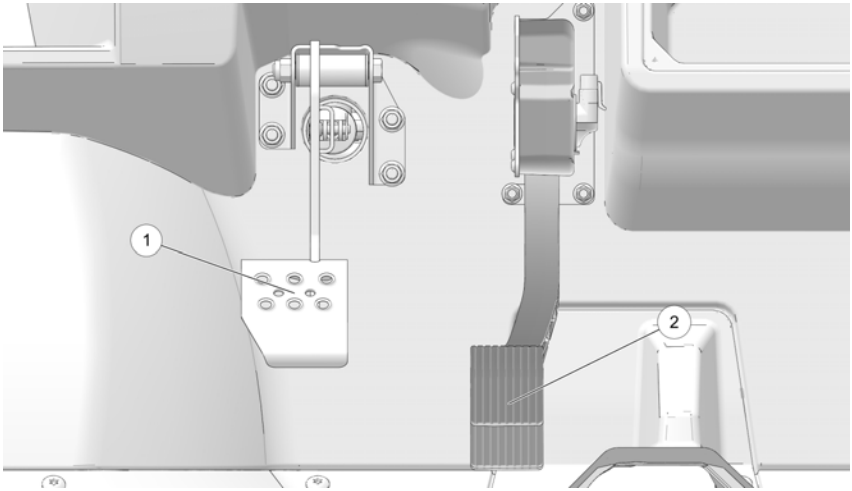

BRAKE PEDAL

Depress the brake pedal ① to slow or stop the vehicle. Apply the brakes while starting the engine.

When the brake pedal is depressed, the brake light comes on. Check the brake light before each ride.

1. Turn the ignition switch to the ON position.
2. Apply the brakes. The brake light should come on after about 10 mm (0.4 in.) of pedal travel.

THROTTLE PEDAL

Push the throttle pedal ② down to increase engine speed. Spring pressure returns the pedal to the rest position when released. Always check that the throttle pedal returns normally before starting the engine.

TIP

If the throttle pedal and brake pedal are applied simultaneously, engine power may be limited.

PARK BRAKE LEVER (IF EQUIPPED)

Always apply the service brakes before engaging or releasing the park brake. To help prevent the vehicle from rolling, set the park brake when parking the vehicle. When the park brake is set and the park brake indicator is illuminated, engine speed is limited. If the accelerator is applied, this limiting feature prevents operation, which protects the park brake pads from excessive wear.

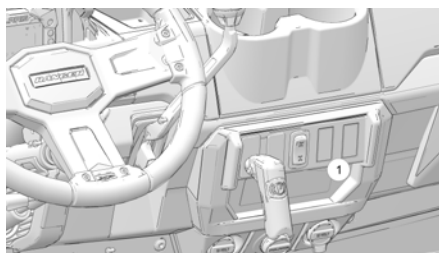

NOTICE

This feature will not operate properly if the park brake connector or switch (under the hood) malfunctions or becomes disconnected, or if the switch has moved. Check for disconnection, then see your dealer or other qualified service person promptly if this feature fails to operate properly.

1. To set the park brake, apply the brakes. Pull the park brake lever ① towards yourself as far as possible.
2. To release the park brake, apply the brakes. Turn the park brake lever counterclockwise and push it in as far as possible.

NOTICE

When the parking brake is engaged, the word "BRAKE" will appear in Display Area 2 of the Instrument Cluster.

SEAT

SEAT BELTS

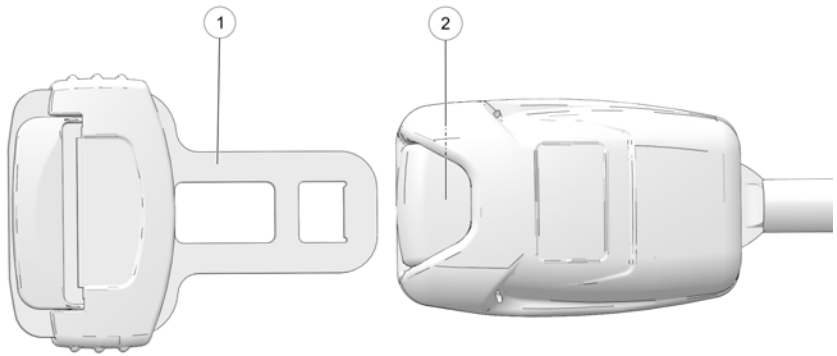

This vehicle is equipped with three-point lap and diagonal seat belts for the operator and any passengers. Always make sure the seat belts are secured for all riders before operating. The driver's seat belt is equipped with a seat belt interlock. Vehicle speed will be limited to 15 MPH (24 km/h) if the seat belt is not secured.

WARNING

Falling from a moving vehicle could result in serious injury or death. Always fasten your seat belt securely before operating or riding in the vehicle.

To wear the seat belt properly, follow this procedure:

1. For 3-point belts, pull the seat belt latch ① downward and across your chest toward the buckle at the inner edge of the seat. The belt should fit snugly across your hips and diagonally across your chest. Make sure the belt is not twisted.
2. Push the latch plate ① into the buckle ② until it clicks.
3. Release the strap, it will self tighten.
4. To release the seat belt, press the square red button in the buckle's center.

FEATURES AND CONTROLS

SEAT BELT INSPECTION



Failure to perform regular inspection can reduce the effectiveness of the seat belt during a crash and could result in serious injury or death.

Inspect all seat belts for proper operation before each use of the vehicle.

1. Push the latch plate into the buckle until it clicks. The latch plate must slide smoothly into the buckle. A click indicates that it's securely latched.
2. Push the red release latch in the middle of the buckle to make sure it releases freely.
3. Pull each seat belt completely out and inspect the full length for any damage, including cuts, wear, fraying or stiffness. If any damage is found, or if the seat belt does not operate properly, have the seat belt system checked and/or replaced by an authorized dealer.
4. To clean dirt or debris from the seat belts, sponge the straps with mild soap and water. Do not use bleach, dye or household detergents. Rinse the entire length of the belt webbing. Use a garden hose to flush out the retractor and latch housings regularly.

SEAT AND STORAGE COMPARTMENTS

The electrical compartment is located under the center rear-most seat. Never use this area for storage. Storage compartments are located under all other seats. Remove the storage bin under the center rear-most seat to access the battery and electrical compartment.

Always make sure all seats are properly installed before operating.

DRIVER'S SEAT

To access the storage area under the driver's seat, reach behind the driver's seat and pull up on the latch. Roll the bottom of the seat forward toward steering wheel.

PASSENGER'S SEAT

To access the storage area under the passenger seat, lift up on the front of the passenger seat and raise it to the upright position.

ELECTRONIC POWER STEERING

Electronic power steering (EPS) engages when the ignition key is turned to the ON position. EPS remains engaged whether the vehicle is moving or idle. To conserve battery power, the EPS will shut down 5 minutes after the engine is stopped if the key remains in the ON position. The EPS warning indicator will illuminate to indicate the EPS has shut down. Turn the key off and on to reset the unit. If the light remains on after starting the engine, the EPS system is inoperative. See your POLARIS dealer, or other qualified person, as soon as possible for repair. Continued operation could result in permanent damage to the EPS unit and increased steering effort.

FUEL CAP

The fuel tank filler cap ① is located on the left-hand side of the vehicle near the driver's seat. To close, tighten the fuel cap until it clicks twice. When refueling, always use unleaded gasoline with a minimum pump octane number of 87 R+M/2 octane. Do not use fuel with ethanol content greater than 10 percent, such as E-85 fuel. Compatible fuels: E5 and E10

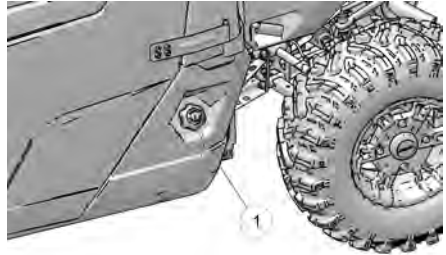

Always ensure that the fuel tank filler cap is fully tightened and secure before operating or transporting the vehicle.

ROLLOVER PROTECTIVE STRUCTURE (ROPS)

The Rollover Protective Structure (ROPS) on this vehicle meets OSHA® 1928.53 rollover performance requirements. Always have your authorized dealer thoroughly inspect the ROPS if it ever becomes damaged in any way.

No device can assure occupant protection in the event of a rollover. Always follow all safe operating practices outlined in this manual to avoid vehicle rollover.

WARNING

Vehicle rollover could cause severe injury or death. Always avoid operating in a manner that could result in vehicle rollover.

FEATURES AND CONTROLS

HOOD LATCHES

To remove the hood, rotate the hood latches ① 1/4-turn and lift the hood away from the vehicle.

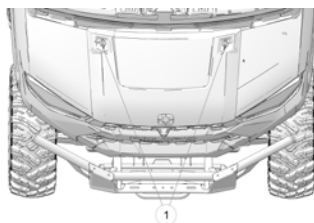

REAR WINDOW PANEL (IF EQUIPPED)

WINDOW REMOVAL

1. Rotate the upper window latches ① counter-clockwise to release the locks.
2. Tilt the upper edge of the window slightly outward and free the lower window brackets ② from the frame, then carefully lift the window up and away from the vehicle.
3. Secure the upper window latches.
4. To prevent damage to the window during storage, store it in an upright position in a secure area. Place the lower frame of the window on wood or another semi-soft surface.

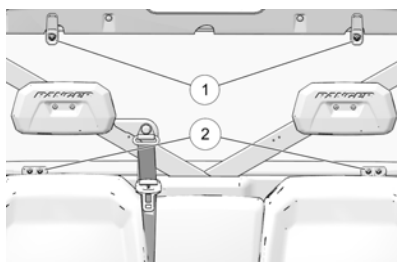

WINDOW INSTALLATION

1. Rotate the upper window latches counter-clockwise to release the locks.
2. From the rear of the cab, place the lower edge of the window into the window opening, hooking the lower window brackets over the frame of the vehicle inside the cab.
3. Align the upper edge of the window to the window opening.
4. Secure the upper window latches.

TRAILER HITCH BRACKET

This vehicle is equipped with a receiver hitch bracket for a trailer hitch. Trailer towing equipment is not supplied with this vehicle.

To avoid injury and property damage, always heed the warnings and towing capacities.

INSTRUMENT CLUSTER

NOTICE

High water pressure may damage components. Wash the vehicle by hand or with a garden hose using mild soap. Certain products, including insect repellents and chemicals, will damage the speedometer lens and other plastic surfaces. Do not use alcohol to clean the instrument cluster. Do not allow insect sprays to contact the lens. Immediately clean off any gasoline that splashes on the instrument cluster.



- | | |
|-------------------|----------------------------|
| ① Speedometer | ④ Mode Button |
| ② Tachometer | ⑤ Toggle Buttons |
| ③ Indicator Lamps | ⑥ Rider Information Center |

SPEEDOMETER

The speedometer displays vehicle speed in either miles per hour (MPH) or kilometers per hour (km/h).

TACHOMETER

The tachometer displays engine speed in revolutions per minute (RPM).

FEATURES AND CONTROLS

MODE AND TOGGLE BUTTONS



Press and hold the MODE button ④ to enter or exit the settings menu. Press and release the MODE button to cycle through Area 1 modes and to select an item.

Press and release either toggle button ⑤ to cycle through the options menu or Area 2 modes. Press and hold either toggle button to reset an item. See page 67.





TIP

With the ignition key off, pressing the MODE button or either toggle button will power up the Rider Information Center for 10 seconds to allow viewing of the odometer and the clock.



INDICATOR LAMPS

| INDICATOR | ICON | FUNCTION |
|---------------------------|---|---|
| Vehicle Speed | MPH | When standard mode is selected, speed displays in miles per hour. |
| | km/h | When metric mode is selected, speed displays in kilometers per hour. |
| Check Engine |  | This indicator appears if a fault occurs. Do not operate the vehicle if this warning appears. Serious engine damage could result. Your authorized POLARIS dealer can assist. |
| Check Battery |  | This warning usually indicates that the vehicle is operating at an RPM too low to keep the battery charged. It may also occur when the engine is at idle and high electrical load (lights, cooling fan, accessories) is applied. Drive at a higher RPM or recharge the battery to clear the warning. |
| EPS Warning (if equipped) |  | This indicator illuminates briefly when the key is turned to the ON position. If the light remains on, the EPS system is inoperative. See your POLARIS dealer, or other qualified person, as soon as possible for repair. Continued operation could result in permanent damage to the EPS unit and increased steering effort. |

FEATURES AND CONTROLS

| INDICATOR | ICON | FUNCTION |
|--------------------------|--|--|
| Engine Hot |  | <p>This lamp illuminates to indicate an overheated engine. If the indicator flashes, the overheating condition remains, and the system will automatically reduce engine power.</p> |
| Neutral |  | <p>This lamp illuminates when the transmission is in neutral and the ignition key is in the ON position.</p> |
| Helmet/Seat Belt |  | <p>This lamp is a reminder to the operator to ensure all riders are wearing helmets and seat belts before operating. The driver's seat belt is equipped with a seat belt interlock. Vehicle speed will be limited to 15 MPH (24 km/h) if the seat belt is not secured.</p> |
| High Beam |  | <p>This lamp illuminates when the headlamp switch is set to high beam.</p> |
| Park Brake (if equipped) |  | <p>Lamp illuminates when the Park Brake is applied (if equipped).</p> |

FEATURES AND CONTROLS

| INDICATOR | ICON | FUNCTION |
|--------------------------------|---|---|
| Low Fuel |  | This lamp illuminates when fuel level in the fuel tank is low. |
| Speed Key (optional accessory) |  | Information about the speed key is provided in the accessory kit. |

RIDER INFORMATION CENTER

| | | |
|---|--------------------------------|--|
| ① | Gear Indicator | This indicator displays gear shifter position. H = High Gear L = Low Gear N = Neutral R = Reverse Gear P = Park – = Gear Signal Error (or shifter between gears) |
| ② | AWD Indicator | This indicator shows whether 2X4, AWD, or TURF Mode is active. |
| ③ | Service Indicator | A flashing wrench symbol alerts the operator that the preset service interval has been reached. Your POLARIS dealer, or other qualified person, can provide scheduled maintenance. See page 70 for resetting instructions. |
| ④ | Fuel Gauge | The segments of the fuel gauge show the level of fuel in the fuel tank. When the last segment clears, a low fuel warning is activated. The outline of the fuel display will flash. Refuel immediately. |
| ⑤ | Speed Limitation (if equipped) | This vehicle may be equipped with a maximum speed limitation function. This would be displayed on the screen as “LIM” followed by the speed. “LIM 30” for example. |

The rider information center is located in the instrument cluster. All segments will light up for one second at start-up. If the instrument cluster fails to illuminate, a battery over-voltage may have occurred and the instrument cluster may have shut off to protect the electronic speedometer. If this occurs, your POLARIS dealer, or other qualified person, can provide proper diagnosis.

The information center is set to display standard units of measurement and a 12-hour clock at the factory. To change to metric and/or a 24-hour clock hold the mode button and cycle to the clock menu. Use the directional arrows to change the clock settings.

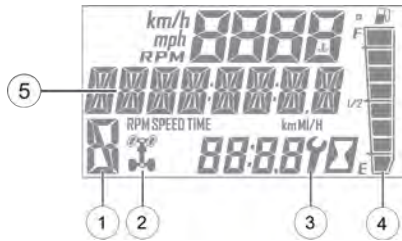

MODE INFORMATION DISPLAYS

The rider information center contains three areas that display mode information.

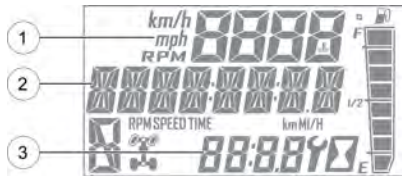

| ① Area 1 Modes | Description |
|---------------------|---|
| Engine Temperature | Temperature of engine coolant |
| Vehicle Speed | Speed of vehicle |
| Tachometer | Engine speed (RPM) |
| ② Area 2 Modes | Description |
| Odometer | The odometer records and displays the distance traveled by the vehicle. |
| Trip Meters (T1/T2) | A trip meter records the distance traveled by the vehicle if reset before each trip. To reset, see page 69. |
| Engine Hours | Total hours of engine operation since manufacture |

FEATURES AND CONTROLS

| | |
|-----------------------|--|
| Service Hours | A flashing wrench symbol indicates that the preset service interval has been reached. To reset, see page 70. |
| Trip Time | Time length of vehicle operation since mode was last reset |
| ③ Area 3 Modes | Description |
| Clock | The clock displays time in a 12-hour or 24-hour format. To reset, see page 68. |

ACCESSING MENUS AND OPTIONS

GAUGE SETTINGS MENU

Press and release the MODE button to cycle through the Area 1 modes until the desired default mode displays. See the Mode Information Displays section for details.

Press and hold the MODE button to enter the settings menu.

The OPTIONS screen will display for a few seconds.

1. Press and release either toggle button to cycle to the desired option.
2. Press MODE to select the option.
3. Press either toggle button to cycle to the desired setting.
4. Press MODE to save and exit to the settings menu.
5. Press and hold the MODE button to exit the settings menu.



BACKLIGHT COLOR

The information center backlight can be set to either blue or red.

1. Press and hold the MODE button to enter the settings menu.
2. Press either toggle button to cycle to the "BL COLOR" option. Press MODE to select.
3. Press either toggle button to cycle to the desired setting.
4. Press MODE to save and exit to the settings menu,



FEATURES AND CONTROLS

BACKLIGHT BRIGHTNESS

The information center backlight can be set to either blue or red.

1. Press and hold the MODE button to enter the settings menu.
2. Press either toggle button to cycle to the "BL LEVEL" option. Press MODE to select.
3. Press "UP" button to increase brightness. Press "DOWN" button to decrease brightness.
4. Press MODE to select and exit to the settings menu.



CLOCK

The clock must be reset any time the battery has been disconnected or discharged.

1. Press and hold the MODE button to enter the settings menu.
2. Press either toggle button to cycle to the "CLOCK" option. Press MODE to select.
3. Press either toggle button to cycle to the desired setting (12H or 24H). Press MODE to select.
4. Press either toggle button to change each segment of the clock. Press MODE to accept a change and advance to the next segment.



DISPLAY UNITS (STANDARD/METRIC)



1. Press and hold the MODE button to enter the settings menu.
2. Press either toggle button to cycle to the desired “UNITS” option (distance, temperature or volume). Press MODE to select.
3. Press either toggle button to cycle to the desired setting.
4. Press MODE to save and exit to the settings menu.

TRIP METER

Use a trip meter to track the distance traveled during a specific trip or period of time. Reset the meter to zero before traveling.

1. Press either toggle button to cycle to the desired trip meter option (T1 or T2).
2. Press and hold either toggle button until the meter resets to zero.



TRIP TIME

Use a trip time meter to track the travel time during a specific trip. Reset the meter to zero before traveling.

1. Press either toggle button to cycle to the trip time option (TT).
2. Press and hold either toggle button until the meter resets to zero.



FEATURES AND CONTROLS

PROGRAMMABLE SERVICE INTERVAL

The service interval counter is programmed to 25 hours at the factory. As hours of engine operation increase, the counter decreases. The wrench icon will flash for about 10 seconds when the counter reaches zero (0), and each time the key is turned on thereafter, until the counter is reset.

When this feature is enabled, it provides a convenient reminder to perform routine maintenance. Refer to the Periodic Maintenance Chart for recommended service intervals.

Use the following procedure to reset or change the service interval.

1. Press and hold the MODE button to enter the settings menu.
2. Press either toggle button to cycle to the "Service Hours" option. Press MODE to select.
3. Press MODE to reset the existing value and exit, or press either toggle button to change the value. Press MODE to save and exit to the settings menu.



ENGINE ERROR CODES

The error screen displays only when the CHECK ENGINE indicator is on or when it goes on and off during one ignition cycle. Error codes are not stored. When the key is turned OFF, the code and message is lost, but will reappear if the fault reoccurs after restarting the engine.

If the CHECK ENGINE lamp or the EPS lamp illuminates, retrieve the active error codes from the display.

- ① Failure Mode Indicator (FMI)
- ② Suspect Parameter Number (SPN)
- ③ Code Count

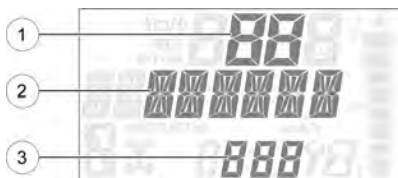

1. Press and hold the MODE button to enter the settings menu.
2. Press either toggle button to cycle to the “DIAGCODE” option. Press MODE to select.
3. More than one diagnostic code may be present. Press the toggle UP button to see if more codes are present. Press MODE to select a code.

NOTICE

If the displayed code is an engine fault code, the CHECK ENGINE lamp will blink. If the displayed code is an EPS fault code, the EPS lamp will blink.

4. Record the three (3) numbers displayed.
5. Press MODE to exit to the settings menu.

RIDE COMMAND DISPLAY (IF EQUIPPED)

BEFORE YOU RIDE

Before riding with your new display, do the following:

- Read this and the Ride Command User's Guide in their entirety.
- Familiarize yourself with the features and operations of the Display while the vehicle is stationary.
- Download the Polaris RIDE COMMAND App from the Apple® App Store® or Google Play® store and create your personalized account.
- Check your display to ensure you have the appropriate maps and trails visible for your area. To change or update maps/trails see page 81.
- Check <https://www.polaris.com/en-us/owners-manuals/> for the latest updates to the owner's manual.

NOTICE

Trails change often, and the trail data file is only considered valid for 90 days after the release date. Please keep your trail data up to date. Download the latest trails at <http://ridecommand.polaris.com>.

NOTICE

Using the display for an extended period of time while the vehicle's engine is off can drain the battery.

DEVICE OPERATING REQUIREMENTS

Phone functionality is dependent on the capabilities of your cell phone.

NOTICE

Some cell phones or operating systems will not work as shown in this manual.

RIDE COMMAND DISPLAY (IF EQUIPPED)

OVERVIEW



① Ride Command Buttons

② Driveline Mode

③ Widgets

④ Settings



⑤ Icon Bar

⑥ Gauge View Mode





⑦ Speedometer/Tachometer

⑧ Gear Status

RIDE COMMAND BUTTONS



| BUTTON | DESCRIPTION | FUNCTION |
|---|---------------------|--|
|  | Menu Button | Press the Menu button to access the settings. To reboot the display, press and hold for 5 seconds. |
|  | Gauge Screen Button | Press the Gauge Screen button to select from available screens. |

RIDE COMMAND DISPLAY (IF EQUIPPED)

| BUTTON | DESCRIPTION | FUNCTION |
|---|------------------------|--|
|  | Map Button | Press the Map button to access the map, manage your rides and waypoints, and to see your friends on the map with Group Ride. |
|  | Phone Button | Press the Phone button to access your Bluetooth® connected phone, including recent calls, contacts, dialer, and messages. |
|  | Audio Button | Press the Audio button to access the Radio, Weather, USB, and connected Bluetooth® music interface |
|  | Volume Decrease Button | Press the Volume Decrease button to decrease the volume. Press and hold to mute volume. |
|  | Volume Increase Button | Press the Volume Increase button to increase the volume. |

RIDE COMMAND DISPLAY (IF EQUIPPED)

DRIVELINE MODE

| INDICATOR | DESCRIPTION | FUNCTION |
|---|-------------------------|--|
|  | 2WD | When the switch is on 2X4, the vehicle is in two-wheel drive at all times. |
|  | AWD | When in All-Wheel Drive, the demand drive unit will automatically engage any time the rear wheels lose traction. When the rear wheels regain traction, the demand drive unit will automatically disengage. There is no limit to the length of time the vehicle may remain in 4X4. The vehicle automatically engages 4X4 when operating in reverse if the switch is set to 4X4 position. |
|  | Turf Mode (if equipped) | When operating in TURF mode, the inside rear wheel will rotate independently from the outside wheel during turns. Operate in TURF mode only as needed to protect smooth, level surfaces from tire damage. DO NOT operate in TURF mode when climbing or descending hills, when sidehilling, or when operating on uneven, loose, or slippery terrain such as sand, gravel, ice, snow, obstacles, and water crossings. Always operate in AWD on these types of terrain. |

GAUGE SCREENS

Press the Gauge Screen button to toggle between gauge screens. The display comes loaded with two different gauge screens. Additional gauge screens can be added or deleted.

Each gauge screen is customizable and can be set up in the following configurations:

- Four round widgets
- Two round widgets and a list of three data values
- A list of five data values

To customize your gauge screens, press the gear icon located in the lower right corner of the display.



SETTINGS

From the setting menu you can view vehicle information, manage Bluetooth® devices, update display software, and more.

To access the Setting menu, press the Menu button ①.

You can also navigate to the settings menu by pressing the POLARIS logo at the top of the display screen ②. This will open the Control Panel. From the Control Panel, select the settings tab, then press the **All Settings** button located in the lower right corner of the display screen.



RIDE COMMAND DISPLAY (IF EQUIPPED)

GAUGE VIEW MODE

Press ① to toggle between the two available gauge view modes, **Analog** and **Digital**.

While in the digital gauge view mode, press ② to invert the MPH and RPM units.



DISPLAY MODE

From the Control tab ③, select the display mode from the available options ⑥.

The display mode can be set to Day, Night, or AUTO mode.

Day Mode



Night Mode



ICON BAR



| ICON | DESCRIPTION | FUNCTION |
|------|---|--|
| ① | Headset | Displays icon if headset is connected |
| ② | Signal Strength | Displays current cell signal strength |
| ③ | Wireless Internet Signal Strength (if equipped) | Displays current wireless internet signal strength (if equipped) |
| ④ | Fuel Level | Displays current fuel capacity percentage |
| ⑤ | Vehicle Direction | Displays vehicle direction |
| ⑥ | Ambient Temperature | Displays ambient temperature |
| ⑦ | Clock | Displays current time |

RIDE COMMAND DISPLAY (IF EQUIPPED)

UPDATE SOFTWARE

NOTICE

Before updating the Display, always export your existing rides and waypoints to a USB drive to avoid losing them.

To update the software, do the following:

ON YOUR PERSONAL COMPUTER

1. Go to ridecommand.polaris.com/update.
2. Log into your account, or create a new account.
3. Using the Vehicle Identification Number (VIN), add your new Polaris vehicle to your Garage.
4. Locate and download the latest software to a USB flash drive (8+ GB).

ON YOUR VEHICLE

1. Connect the USB flash drive to the USB cable and power up your vehicle.
2. On the RIDE COMMAND display, select the Settings menu on your display by pressing the POLARIS icon at the top of the screen.
3. Select General Settings, then Update Software.
4. Select the file you wish to load (use date listed in the file name to determine most recent file).
5. Select Yes to restart display (restart required).

ERROR MESSAGES

If an error occurs while updating your software, perform one or all of the following actions to resolve the issue:

1. Remove and reconnect the USB flash drive securely.
2. Make sure the display files are not inside a folder on the flash drive.
3. Make sure only display files are on the flash drive. Remove any other files if necessary.
4. Try using a different USB flash drive.

UPDATE MAPS

To update the maps on your display, do the following:

1. Go to ridecommand.polaris.com/update and download the map update to a USB flash drive.
2. Insert USB flash drive into the USB port on your vehicle.
3. Press the Update maps in the General Settings.
4. Select the file you want to install by pressing the corresponding down arrow icon.
5. This will update the display's map which will automatically restart the display once the update is complete. Do not remove the USB flash drive until the display has fully restarted.

USB HARDWARE

SOFTWARE UPDATES

For software update, POLARIS recommends using a SanDisk® or similar USB flash drive with a minimum of 4GB in available memory, formatted using the FAT32 or exFAT® file systems. For best results remove all files from the flash drive before starting the update process.

MAP UPDATES

For Map updates, a 32GB USB drive is required (USB 3.0 drive is highly recommended) USB drive must be formatted to exFAT® before copying the map file onto it.

TRAIL UPDATES

For Trail updates, a 4GB drive formatted to FAT32 can be used.

OPERATION

IMPORTANT INFORMATION

WARNING

Failure to operate the vehicle properly can result in a collision, loss of control, accident or rollover, which may result in serious injury or death. Read and understand all safety warnings outlined in the safety section of this owner's manual.

VEHICLE BREAK-IN PERIOD

The break-in period for your new vehicle is the first 25 hours of operation, or the time it takes to use the first 2 full tanks of gasoline. No single action on your part is as important as a proper break-in period. Careful treatment of a new engine will result in more efficient performance and longer life for the engine. Perform the following procedures carefully.

NOTICE

Excessive heat build-up during the first 3 hours of operation will damage close-fitted engine parts and drive components. Do not operate at full throttle or high speeds during the first 3 hours of use.

ENGINE AND DRIVETRAIN BREAK-IN

1. Fill the fuel tank with gasoline. Always exercise extreme caution whenever handling gasoline.
2. Check the oil level. Add the recommended oil as needed to maintain the oil level in the safe operating range.
3. Complete the New Operator Driving Procedures.
4. Avoid aggressive use of the brakes.
5. Vary throttle positions. Do not operate at sustained idle.
6. Pull only light loads.
7. Perform regular checks on fluid levels, controls and areas outlined on the daily pre-ride inspection checklist.
8. During the break-in period, change both the oil and the filter at 25 hours or one month.
9. Check fluid levels of transmission and all gearcases after the first 25 hours of operation and every 100 hours thereafter.

OPERATION

BRAKE SYSTEM BREAK-IN

Apply only moderate braking force for the first 50 stops. Aggressive or overly forceful braking when the brake system is new could damage brake pads and rotors.

PVT BREAK-IN (CLUTCHES/BELT)

Always break in the clutches and drive belt of new vehicles, as well as after a belt replacement.

A proper break-in of the clutches and drive belt will ensure a longer life and better performance. Break in the clutches and belt by operating at slower speeds during the break-in period as recommended. Pull only light loads. Avoid aggressive acceleration and high speed operation during the break-in period.

If a belt fails, always clean any debris from the PVT intake and outlet duct and from the clutch and engine compartments when replacing the belt.

PRE-RIDE INSPECTION



Failure to inspect and verify that the vehicle is in safe operating condition before operating increases the risk of an accident. Always inspect the vehicle before each use to make sure it's in safe operating condition.

| ITEM | REMARKS | PAGE |
|------------------------------|-------------------------------------|----------|
| Brake system/pedal travel | Ensure proper operation | page 124 |
| Brake fluid | Ensure proper level | page 124 |
| Front suspension | Inspect, lubricate if necessary | page 101 |
| Rear suspension | Inspect, lubricate if necessary | page 101 |
| Steering | Ensure free operation | - |
| Tires | Inspect condition and pressure | page 129 |
| Wheels/fasteners | Inspect, ensure fastener tightness | page 129 |
| Frame nuts, bolts, fasteners | Inspect, ensure tightness | - |
| Drive Belt | Inspect, ensure installed correctly | - |
| Fuel and oil | Ensure proper levels | page 103 |
| Coolant level | Ensure proper level | page 112 |
| Coolant hoses | Inspect for leaks | - |

| ITEM | REMARKS | PAGE |
|---------------------------|---|--------------------|
| Throttle | Ensure proper operation | page 55 |
| Indicator lights/switches | Ensure proper operation | page 62 page 50 |
| Intake pre-filters | Inspect, clean | - |
| Headlamps | Check operation, apply POLARIS dielectric grease when lamp is replaced | page 132 |
| Brake light/tail lamps | Check operation | - |
| Seat Latch | Push down on the seat back to ensure the latch is secure | - |
| Seat Belt | Check length of belt for damage, check latches for proper operation | page 57 |
| Cab Doors (if equipped) | Check doors and latches for wear or damage. | - |
| Grass and leaves | Remove grass, leaves, foreign matter, and other flammable material or debris, especially near the exhaust system. | - |

SAFE OPERATION PRACTICES

1. Visit the Recreational Off-Highway Vehicle Association® web site and take the free on-line training course. Complete the recommended safety training before operating this vehicle. Visit www.rohva.org or call 866-267-2751.
2. Do not allow anyone under 16 years of age or without a valid driver's license to operate this vehicle.
3. Engine exhaust fumes are poisonous and can cause loss of consciousness or death in a short time. Never start the engine or let it run in an enclosed area.
4. Never operate with accessories not approved by POLARIS for use on this vehicle.
5. Operate this vehicle off-road only. Never operate this vehicle on any public street, road or highway, including dirt and gravel roads (unless designated for off-highway use).
6. Use caution and drive at reduced speeds in conditions of reduced visibility such as fog, rain and darkness. Clean headlights frequently and replace burned out headlamps promptly.
7. Always operate at a speed that's appropriate for the terrain, the visibility and operating conditions and your skills and experience. Never operate at excessive speeds. Never attempt wheelies, jumps, or other stunts. Keep both hands on the steering wheel during operation.
8. Never consume alcohol or drugs before or while operating this vehicle.
9. Always use the size and type of tires specified for your vehicle. Always maintain proper tire pressure.
10. Never operate a damaged vehicle. After any rollover or accident, have a qualified service dealer inspect the entire machine for possible damage.
11. Never operate the vehicle on a frozen body of water unless you have first verified that the ice is sufficiently thick to support the weight and moving force of the vehicle, you and your cargo, together with any other vehicles in your party.
12. Do not touch hot exhaust system components. Always keep combustible materials away from the exhaust system.
13. Always remove the ignition key when the vehicle is not in use to prevent unauthorized use.

KNOW YOUR RIDING AREA/TREAD LIGHTLYSM

Familiarize yourself with all laws and regulations concerning the operation of this vehicle in your area. Respect the environment in which you ride your vehicle. Find out where the designated riding areas are by contacting your POLARIS dealer, a local riding club, or local officials.

Help keep our trails open for recreational vehicle use. As an off-road enthusiast, you represent the sport and can set a good example (or a poor example) for others to follow. Tread LightlySM. Operate with respect for the terrain, avoid littering, and always stay on the designated trails.

TRAIL ETIQUETTE

Always practice good etiquette when riding. Allow a safe distance between your vehicle and other vehicles operating in the same area. Communicate to oncoming operators by signaling the number of vehicles in your group. When stopping, move your vehicle to the edge of the trail as far as possible to allow others to pass safely.

STARTING THE ENGINE

1. Position the vehicle on a level surface outdoors or in a well ventilated area.
2. Sit in the driver's seat and fasten the seat belt. Secure the cab doors (if equipped).
3. Place the transmission in PARK.
4. Apply the brakes. Do not press the throttle pedal while starting the engine.
5. Turn the ignition key past the ON/RUN position to START. Engage the starter for a maximum of five seconds. Release the key when the engine starts.
6. If the engine does not start within five seconds, return the ignition switch to the OFF position and wait five seconds. Repeat steps 5 and 6 until the engine starts.
7. Vary the engine RPM slightly with the throttle to aid in warm up until the engine idles smoothly.

NOTICE

Operating the vehicle immediately after starting could cause engine damage. Allow the engine to warm up for several minutes before operating the vehicle.

OPERATION

USING LOW GEAR

Low gear is the primary driving range for the RANGER. High gear is intended for use on hard-packed surfaces with light loads. Whenever the vehicle is left unattended, always place the transmission in PARK.

Always shift into low gear for any of the following conditions.

- Operating in rough terrain or over obstacles
- Loading the vehicle onto a trailer
- Towing heavy loads
- Driving slowly - under 10 MPH (16 km/h)
- Climbing hills

COLD WEATHER OPERATION

If the vehicle is used year-round, check the oil level frequently. A rising oil level could indicate the accumulation of contaminants such as water or excess fuel in the bottom of the crankcase. Water in the bottom of the crankcase can lead to engine damage and must be drained. Water accumulation increases as outside temperature decreases.

FUEL RECOMMENDATIONS

Most Polaris Off-Road Vehicles require unleaded gasoline with a minimum pump octane number of 87. Do not use fuel with an ethanol content greater than 10 percent. Octane in excess of 87 will not damage the engine but typically will not result in performance gains.

Be aware that fuel is mixed differently depending on the season. Summer fuel has a low Reid Vapor Pressure (RVP), which makes it less likely to evaporate in warm weather riding. This prevents vapor lock issues. Winter fuel has a higher RVP, which increases evaporation to ease starting in cold weather conditions. In winter, it's important to drain your tank and fill it with fresh fuel from a high volume gas station. This ensures your fuel is a winter blend. After filling the tank, run the engine for 10 to 15 minutes. This will fill the fuel system with the fresh winter-blended fuel.

STOPPING THE ENGINE

1. Release the throttle pedal completely and brake to a complete stop.
2. Place the transmission in PARK.
3. Turn the key to the OFF position.
4. Slowly release the brake pedal and make sure the transmission is in PARK before exiting the vehicle.

 **WARNING**

A rolling vehicle can cause serious injury. Always place the transmission in PARK before stopping the engine.

BRAKING

1. Release the throttle pedal completely.

NOTICE

When the throttle pedal is released completely and engine speed slows to near idle, the vehicle has no engine braking.

2. Press on the brake pedal evenly and firmly. Practice starting and stopping (using the brakes) until you're familiar with the controls.

PARKING THE VEHICLE

1. Stop the vehicle on a level surface. When parking inside a garage or other structure, be sure that the structure is well ventilated and that the vehicle is not close to any source of flame or sparks, including any appliance with pilot lights.
2. Place the transmission in PARK.
3. Turn the engine off.
4. Engage the parking brake (if equipped).
5. Slowly release the brake pedal and make sure the transmission is in PARK before exiting the vehicle.
6. Remove the ignition key to prevent unauthorized use.

HAULING CARGO

WARNING

Overloading the vehicle or carrying or towing cargo improperly can alter vehicle handling and may cause loss of control or brake instability. Always follow these precautions when hauling cargo:

Never exceed the stated load capacity for this vehicle.

REDUCE SPEED AND ALLOW GREATER DISTANCES FOR BRAKING WHEN HAULING CARGO.

NEVER EXCEED THE MAXIMUM WEIGHT CAPACITY of the vehicle. When determining the weight you are adding to the vehicle, include the weight of the operator, passenger, accessories, loads in the rack or box and the load on the trailer tongue. The combined weight of these items must not exceed the maximum weight capacity.

Always load the cargo box with the load as far forward and as low as possible. When operating over rough or hilly terrain, reduce speed and cargo to maintain stable driving conditions.

Always operate the vehicle with extreme care when hauling or towing loads. Slow down and drive in the lowest gear available.

SECURE ALL LOADS BEFORE OPERATING. Unsecured loads can create unstable operating conditions, which could result in loss of control of the vehicle.

OPERATE ONLY WITH STABLE AND SAFELY ARRANGED LOADS. When handling off-centered loads that cannot be centered, securely fasten the load and operate with extra caution.

Always attach the tow load to the hitch point designated for your vehicle.

HEAVY LOADS CAN CAUSE BRAKING AND CONTROL PROBLEMS. Use extreme caution when applying brakes with a loaded vehicle. Avoid terrain or situations that may require backing downhill.

USE EXTREME CAUTION when operating with loads that extend over the rack sides. Stability and maneuverability may be adversely affected, causing vehicle rollover.

DO NOT TRAVEL FASTER THAN THE RECOMMENDED SPEEDS. Vehicle should never exceed 10 MPH (16 km/h) while towing a load on a level grass surface. Vehicle speed should never exceed 5 MPH (8 km/h) when towing loads in rough terrain, while cornering, or while ascending or descending a hill.

If the vehicle is capable, never exceed 43 MPH (70 km/h) if total payload exceeds 335 lbs. (152 kg).

Carrying a passenger in the cargo box could result in a fall from the vehicle or contact with moving components. Never allow a passenger to ride in the cargo box.

Your vehicle has been designed to carry or tow specific capacities. Reduce speed and allow a greater distance for braking when carrying cargo.

Loads should be centered on the vehicle and carried as low as possible in the box. For stability on rough or hilly terrain, reduce both speed and cargo. Exercise caution if the cargo load extends over the side of the box.

Always read and understand the load distribution warnings listed on warning labels and in this manual. Never exceed the maximum capacities specified for your vehicle.

BELT LIFE

To extend belt life, use low gear when hauling or towing heavy cargo.

TOWING LOADS



WARNING

Towing improperly can alter vehicle handling and may cause loss of control or brake instability.

Always follow these precautions when towing:

1. Never load more than 250 lbs. (113.4 kg) tongue weight on the towing bracket.
2. When towing a disabled vehicle, place the disabled vehicle's transmission in neutral. Do not operate the vehicle faster than 10 MPH (16 km/h) when towing.
3. Towing a trailer increases braking distance. Do not operate the vehicle faster than 10 MPH (16 km/h) when towing.
4. Do not tow more than the recommended weight for the vehicle.
5. Attach a trailer to the trailer hitch bracket only. Do not attach a trailer to any other location, which could result in loss of control of the vehicle.
6. The total load (operator, accessories, cargo and weight on hitch) must not exceed the maximum weight capacity of the vehicle.

| MODEL | TOTAL TOWED LOAD WEIGHT (LEVEL GROUND) | TOTAL TOWED LOAD WEIGHT (15° GRADE) | TOTAL HITCH VERTICAL WEIGHT | MAXIMUM TOWING SPEED |
|----------------------------------|--|-------------------------------------|-----------------------------|----------------------|
| All <i>RANGER</i> XP 1000 models | 2500 lbs. (1134 kg) | 850 lbs. (386 kg) | 250 lbs (113.4 kg) | 10 MPH (16 km/h) |

DUMPING THE CARGO BOX

To dump the cargo box, do the following:

1. Select a level site to dump the cargo box. Do not attempt to dump or unload the vehicle while parked on an incline.
2. Apply the brakes.
3. Shift the gear selector to the Park position.
4. Turn the key to the off position.
5. Dismount vehicle.
6. Ensure that the cargo is positioned evenly or toward the front of the cargo box.
7. Open the tailgate.
8. Stand clear and pull up on the cargo box release lever.
9. Lift the front of the cargo box to dump the cargo.
10. Lower the cargo box and push down securely to latch.
11. Close the tailgate.

 **WARNING**

Operating the vehicle while the cargo box is raised could result in severe injury. The box could close unexpectedly and cause injury to the driver or passenger. The rear tires will also catch the rear of a raised box, damaging the vehicle and creating hazardous driving conditions. Never operate this vehicle with the cargo box in the raised position.

ALL WHEEL DRIVE/REAR DIFFERENTIAL SYSTEM

If your model is equipped with a lockable differential, you can choose to operate with an open differential or a closed differential.

ENGAGING AWD

NOTICE

Switching to AWD while the rear wheels are spinning may cause severe drive shaft and clutch damage. Always switch to AWD while the rear wheels have traction or are at rest.

- ① All-Wheel Drive (AWD)
- ② Differential Lock
- ③ Differential Unlock (Turf Mode)

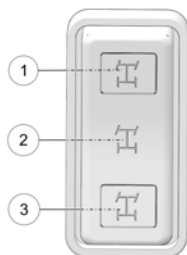

Press the top of the switch to engage All Wheel Drive (AWD). The 4X4 indicator illuminates in the rider information center to indicate that the vehicle is in AWD. When the AWD switch is on, the front gearcase will automatically engage any time the rear wheels lose traction. When the rear wheels regain traction, the front gearcase will automatically disengage. There is no limit to the length of time the vehicle may remain in AWD. Initially, the vehicle's electronic system will not enable the AWD until the engine RPM is below 3100. Once enabled, the AWD remains enabled until the AWD switch is turned off. If the switch is turned off while the front gearcase is moving, it will not disengage until the rear wheels regain traction.

Engage the AWD before getting into conditions where front wheel drive may be needed. If the rear wheels are spinning, release the throttle before switching to AWD.

OPERATION

DISENGAGING AWD

Move the AWD switch to the center or bottom position to disengage AWD. If the switch is turned off while the front hubs are driving, they will not release until the rear wheels regain traction.

In some situations, the front gearcase may remain locked after turning the AWD switch off. If this occurs, you may notice increased steering effort and some vehicle speed restriction. Perform the following procedure to unlock the front gearcase.

To disengage AWD, do the following:

1. Stop the vehicle.
2. Operate in reverse for at least 10 ft (3 m).
3. Stop completely.
4. Shift into low gear and drive forward.
5. If the front gearcase remains locked after following these instructions, see your dealer or other qualified service person for service.

LOCKING THE DIFFERENTIAL

Move the rocker switch to the center position to lock the differential and operate in two wheel drive (2WD). Locking the differential in slippery or low traction conditions helps improve traction. When the rear differential is locked, both rear wheels rotate at the same speed.

UNLOCKING THE DIFFERENTIAL (TURF MODE)

When operating in TURF mode, the inside rear wheel will rotate independently from the outside wheel during turns. Operate in TURF mode only as needed to protect smooth, level surfaces from tire damage. DO NOT operate in TURF mode when climbing or descending hills, when sidehilling, or when operating on uneven, loose, or slippery terrain such as sand, gravel, ice, snow, obstacles, and water crossings. Always operate in AWD on these types of terrain.

WARNING

Operating in TURF mode (if equipped) when on sloped, uneven, or loose terrain could cause loss of control and result in serious injury or death. One rear wheel may slip and lose traction and may lift up and grab when it touches the ground again.

Press the bottom of the switch to unlock the differential and allow the rear drive wheels to operate independently (1WD). When the rear differential is unlocked, the rear wheels can rotate at different speeds. Unlock the differential to make maneuvering easier and minimize damage to turf.

NOTICE

Damage to the differential can occur if it is engaged while the vehicle is traveling at high speeds or while the rear wheels are spinning. Slow the vehicle to nearly stopped before engaging the differential.

WARNING

Never operate in TURF mode (if equipped) while operating on a hill or other irregular terrain. Always move the AWD switch to AWD before ascending or descending a hill.

EMISSION CONTROL SYSTEMS

NOISE EMISSION CONTROL SYSTEM

Do not modify the engine, intake or exhaust components, as doing so may affect compliance with U.S.A. EPA noise control requirements (40 CFR 205) and local noise level requirements.

OPERATION ON PUBLIC LANDS IN THE U.S.A.

Your vehicle has a spark arrester that was tested and qualified to be in accordance with the USFS standard 5100-1a. Federal law requires that this spark arrester be installed and functional when the vehicle is operated on public lands.

Operation of off-road vehicles on public lands in the U.S.A. is regulated by 43 CFR 420. Violations are subject to monetary penalties. Federal regulations can be viewed online at <https://ecfr.federalregister.gov/current/title-43/subtitle-B/chapter-1/part-420>.

CRANKCASE EMISSION CONTROL SYSTEM

This engine is equipped with a closed crankcase system. Blow-by gases are forced back to the combustion chamber by the intake system. All exhaust gases exit through the exhaust system.

EXHAUST EMISSION CONTROL SYSTEM

Exhaust emissions are controlled by engine design. An electronic fuel injection (EFI) system controls fuel delivery. The engine and EFI components are set at the factory for optimal performance and are not adjustable.

The emissions label is located on the inside of the lower left frame tube (below driver's foot area).

ELECTROMAGNETIC INTERFERENCE

This spark ignition system complies with Canadian ICES-002.

This vehicle complies with the EMC requirements of UN ECE Regulation 10.

Non-ionizing Radiation: This vehicle emits some electromagnetic energy. People with active or non-active implantable medical devices (such as heart monitoring or controlling devices) should review the limitations of their device and the applicable electromagnetic standards and directives that apply to this vehicle.

MAINTENANCE

POLARIS MAINTENANCE SCHEDULE

The intervals shown in this table are based on vehicles operated under normal conditions.

Each interval is given in hours and miles (kilometers). Items should be serviced at whichever interval comes first.

Continue to reference the following maintenance schedules at the given intervals as hours and miles (kilometers) increase on the vehicle.

Vehicles subjected to severe use must be serviced at 50% of the stated interval. Examples of Severe Use: Frequent immersion in mud, water, or sand, constant high RPM use, prolonged low-speed heavy load operation, extended idle, and short trip cold weather operation.

INITIAL BREAK-IN SERVICE FIRST 25 HOURS / 500 MILES (800 KM)

| | |
|--|---|
| Brake System | Initial fluid level inspection; inspect for fluid leaks; add lubricant if needed. Inspect brake pad wear. |
| Engine Oil and Filter | Change the engine oil and filter. |
| Front Gearcase Fluid | Initial fluid level inspection. |
| Transmission Fluid | Initial fluid level inspection; inspect for fluid leaks; add lubricant if needed. |
| The break-in period consists of the first 25 hours of operation. Careful treatment of a new engine and drive components will result in more efficient performance and longer life for these components. The items outlined in this service interval only need to be performed at the first 25 hours of operation. They do not need to be performed every 25 hours. | |

Vehicles subjected to severe use must be serviced at 50% of the stated interval. Examples of Severe Use: Frequent immersion in mud, water, or sand, constant high RPM use, prolonged low-speed heavy load operation, extended idle, and short trip cold weather operation.

EVERY 50 HOURS / 500 MILES (800 KM)

| | |
|---------------------|--|
| Brake Pad Wear | Inspect; replace as needed. |
| General Lubrication | Locate all applicable fittings and grease. |
| Engine Breather | Inspect; clean as needed. |

MAINTENANCE

Vehicles subjected to severe use must be serviced at 50% of the stated interval. Examples of Severe Use: Frequent immersion in mud, water, or sand, constant high RPM use, prolonged low-speed heavy load operation, extended idle, and short trip cold weather operation.

EVERY 100 HOURS / 1000 MILES (1600 KM) OR YEARLY

| | |
|--------------------------------|---|
| Air Filter | Replace air filter. Ensure proper installation of filter and airbox cover. Inspect ducts and screens; clean as necessary. |
| Battery | Check terminals; terminals should be tight and free of corrosion. Clean, test, and replace as necessary. |
| Brake Pad Wear | Inspect; replace as needed. |
| Clutches* | Inspect bushings, rollers, wearable parts; clean; replace worn parts. Inspect drive belt. |
| Cooling System | Fluid level inspection; inspect for fluid leaks; add coolant if needed. Inspect coolant strength seasonally; pressure test system yearly. |
| Drive Belt | Inspect; replace as needed. |
| Engine Breather | Inspect; clean as needed. |
| Engine Oil and Filter | Change the engine oil and filter. |
| Exhaust Silencer / Pipe | Inspect for leaks or damage. |
| Front Gearcase Fluid | Change fluid. |
| Front / Rear Suspension | Lubricate (if applicable). |
| Fuel System* | Cycle key to pressurize fuel pump; check for leaks at fuel system connections, check for leaks at fill cap. |
| General Lubrication | Locate all applicable fittings and grease. |
| Parking Brake (if applicable)* | Inspect and adjust as needed. |
| Spark Arrestor | Clean out. |
| Spark Plugs | Inspect; replace as needed. |

EVERY 100 HOURS / 1000 MILES (1600 KM) OR YEARLY

| | |
|--|--|
| Suspension Components* | Inspect tie rods, wheel bearings, suspension bushings, and ball joints for loose or worn components; replace as needed. Inspect shock absorbers for leaks or damage. |
| Transmission Fluid | Change fluid. |
| Wiring | Inspect for wear, routing, and retention. |
| * It is recommended to have an authorized Polaris dealer perform these services. | |

Vehicles subjected to severe use must be serviced at 50% of the stated interval. Examples of Severe Use: Frequent immersion in mud, water, or sand, constant high RPM use, prolonged low-speed heavy load operation, extended idle, and short trip cold weather operation.

ADDITIONAL MAINTENANCE INTERVALS

| | | |
|--|------------------|---|
| Every 200 hours / 2000 miles (3200 km) | Shock Absorbers* | Change shock oil or rebuild (if applicable). Inspect seals and replace as needed. |
| Every 310 hours / 3100 miles (5000 km) | Valve Clearance* | Inspect; adjust as needed. |
| Every 24 months / 2 years | Brake Fluid | Change fluid. |
| Every 60 months / 5 years | Coolant | Change fluid. |
| * It is recommended to have an authorized Polaris dealer perform these services. | | |

LUBRICATION RECOMMENDATIONS

Check and lubricate all components at the intervals outlined in the Periodic Maintenance Chart, or more often under severe use, such as wet or dusty conditions. Items not listed in the chart should be lubricated at the general lubrication interval.

MAINTENANCE

| ITEM | LUBE | METHOD |
|--|--|---|
| Engine Oil | PS-4 5W-50 4-Cycle Oil | Add to proper level on dipstick. See page 103. |
| Brake Fluid | DOT 4 Brake Fluid | Maintain level between fill lines. See page 124. |
| Transmission Oil (Main Gearcase) | AGL Gearcase Lubricant & Transmission Fluid | See page 108. |
| Demand Drive Fluid (Front Gearcase) | Demand Drive Fluid | See page 110. |
| Prop Shaft | U-Joint Grease | Locate fittings and grease. |

ENGINE OIL

Always check and change the oil at the intervals outlined in the Periodic Maintenance Chart. Always use the recommended engine oil. Always change the oil filter whenever changing oil.

Pay special attention to the oil level. A rise in oil level during cold weather can indicate contaminants collecting in the oil sump or crankcase. Change oil immediately if the oil level begins to rise. Monitor the oil level, and if it continues to rise, discontinue use and determine the cause. Your dealer can assist.

 **WARNING**

Vehicle operation with insufficient, deteriorated, or contaminated engine oil will cause accelerated wear and may result in engine seizure, accident and injury. Always perform the maintenance procedures as outlined in the Periodic Maintenance Chart.

MAINTENANCE

OIL RECOMMENDATIONS

POLARIS recommends the use of POLARIS PS-4 5W-50 4-Cycle Oil or a similar oil. Refer to the Specifications section for capacities.

Oil may need to be changed more frequently if POLARIS PS-4 engine oil is not used. Follow the manufacturer's recommendations for ambient temperature operation. See the Polaris Products section for part numbers.

NOTICE

Mixing brands or using a non-recommended oil may cause serious engine damage. Always use the recommended oil. Never substitute or mix oil brands.

OIL CHECK

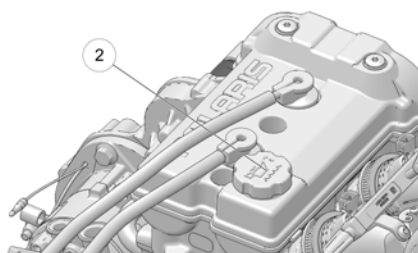
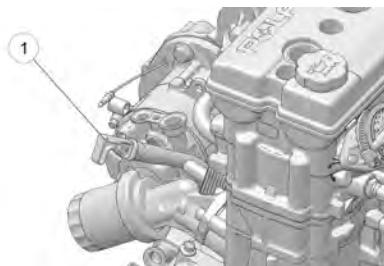

The oil dipstick is located on the engine. Access the dipstick through either the right or left wheel well (depending on your model).

To check the oil, do the following:

1. Position vehicle on a level surface and place the transmission in PARK.
2. Stop the engine and allow it to cool down before removing the dipstick.
3. Raise the cargo box. Unlock the dipstick lever ①. Remove the dipstick and wipe it dry with a clean cloth.
4. Reinstall the dipstick and push it into place. Do not lock the dipstick.

NOTICE

Make certain the dipstick is inserted all the way into the dipstick tube to keep the depth of the dipstick consistent.

5. Remove the dipstick and check the oil level.

6. Add the recommended oil as necessary to bring the oil level within the SAFE range on dipstick. Do not overfill (see *NOTICE* below).

NOTICE

A rising oil level between checks during cold weather operation can indicate contaminants such as gas or moisture collecting in the crankcase. If the oil level is over the upper mark, change the oil immediately.

7. With the cargo box raised, add engine oil through the oil fill cap ② located on top of the valve cover, under the cargo box.
8. When finished, reinstall dipstick and lock the lever. Lower the cargo box and secure in position.

ENGINE OIL AND FILTER REPLACEMENT

Always change engine oil and filter at the intervals outlined in the Periodic Maintenance Chart. Always change the oil filter ① whenever changing the engine oil.

The engine oil dipstick is located on the right front side of the engine. The engine oil fill cap is located on top of the valve cover. Access the oil dipstick and oil fill cap by tilting the rear cargo box.

The crankcase drain plug ② is located on the bottom of the crankcase. Access the drain plug through the skid plate access hole located directly under the crankcase.

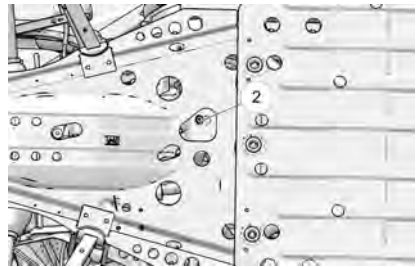
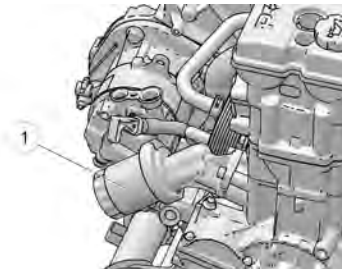

1. Position vehicle on a level surface and place the transmission in PARK.
2. Stop the engine and allow it to cool down.
3. Clean the area around the crankcase drain plug.

⚠ CAUTION

Use caution when performing this procedure. Do not allow hot engine oil to come into contact with skin, as serious burns may result.

MAINTENANCE

- Place a drain pan under the engine crankcase and remove the drain plug. Allow the oil to drain completely.
- Remove all cargo from the cargo box.

CAUTION

Always remove all cargo from the cargo box before lifting the box to access the engine.

- Pull up on the cargo box release lever to tilt the box.
- Using the Oil Filter Wrench, turn the oil filter ② counter-clockwise to remove it.
- Using a clean dry cloth, clean the filter sealing surface on the engine crankcase.
- Lubricate the O-ring on the new oil filter with a film of fresh engine oil. Check to make sure the O-ring is in good condition. Install it to specification.

TORQUE

Oil Filter

Turn by hand until filter O-ring contacts sealing surface, then turn an additional 3/4 turn.

- Replace the sealing washer on drain plug.

NOTICE

The sealing surface on the drain plug should be clean and free of burrs, nicks or scratches.

- Reinstall the engine crankcase drain plug. Torque drain plug to specification.

TORQUE

Crankcase Drain Plug
12 ft-lbs (16 N·m)

- Remove oil fill cap. Fill engine with recommended engine oil.
- Verify the transmission is still in PARK.
- Start the engine and allow it to idle for 30 seconds.
- Stop the engine and inspect for oil leaks. Wait at least 15 seconds before removing the dipstick.

16. Unlock the dipstick lever. Remove the dipstick and wipe it dry with a clean cloth.
17. Reinstall the dipstick and push it into place. Do not lock the dipstick.

NOTICE

Make certain the dipstick is inserted all the way into the dipstick tube to keep the depth of the dipstick consistent.

18. Remove the dipstick and check the oil level.
19. Add the recommended oil as necessary to bring the oil level within the SAFE range on dipstick. Do not overfill.
20. When finished, reinstall the oil fill cap, oil dipstick and lock the lever.
21. Dispose of used oil and filter properly.

GEARCASES

GEARCASE SPECIFICATION CHART

| GEARCASE | LUBRICANT | CAPACITY | FILL PLUG TORQUE | DRAIN PLUG/ LEVEL CHECK PLUG TORQUE |
|--|---|-------------------|--------------------------|-------------------------------------|
| Transmission (Main Gearcase) | AGL Gearcase Lubricant & Transmission Fluid | 51 oz. (1500 ml) | 10-14 ft-lbs (14-19 Nm) | 10-14 ft-lbs (14-19 Nm) |
| Demand Drive Unit (Front Gearcase) | Demand Drive Fluid | 6.8 oz. (200 ml)* | 8-10 ft-lbs (11-13.6 Nm) | 11 ft-lbs (15 Nm) |
| *If your vehicle is equipped with high mounted intakes: 9.3 oz. (275 ml) | | | | |

TRANSMISSION (MAIN GEARCASE)

TRANSMISSION OIL CHECK

Always check and change the transmission oil at the intervals outlined in the Periodic Maintenance Chart. Maintain the oil level even with the bottom thread of the fill plug hole.

The fill plug is located on the rear of the gearcase. Maintain the fluid level at the bottom of the fill plug hole.

To check the transmission fluid, do the following:

1. Position the vehicle on a level surface.
2. Remove the fill plug ①.
3. Check the fluid level.
4. Add the recommended fluid to the bottom of the fill plug hole. Do not overfill.
5. Reinstall the fill plug. Torque to specification.

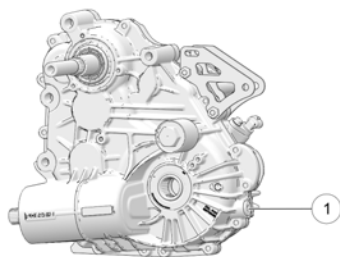

TRANSMISSION OIL CHANGE

The drain plug is located on the bottom of the gearcase. Access the drain plug through the hole in the skid plate.

1. Remove the fill plug ①.
2. Place a drain pan under the drain plug ②.
3. Remove the drain plug. Allow the fluid to drain completely.
4. Clean and reinstall the drain plug. Torque to specification.
5. Add the recommended fluid to the bottom of the fill plug hole. Do not overfill.
6. Reinstall the fill plug. Torque to specification.
7. Check for leaks. Discard used fluid properly.

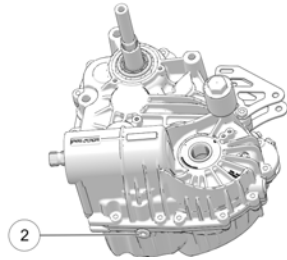

DEMAND DRIVE (FRONT GEARCASE)

DEMAND DRIVE OIL CHECK

Always check and change the demand drive fluid at the intervals outlined in the Periodic Maintenance Chart. Maintain the oil level even with the bottom thread of the fill plug hole. Refer to the Gearcase Specifications Chart for recommended lubricants, capacities and torque specifications.

The front gearcase fill plug ① is located on the right side of the front gearcase.

1. Position the vehicle on a level surface.
2. Remove the fill plug ①. Check the oil level.
3. Add the recommended oil as needed.
4. Reinstall the fill plug. Torque to specification.

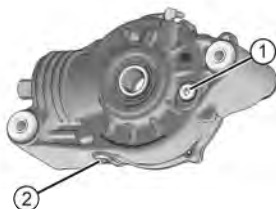

DEMAND DRIVE OIL CHANGE

1. Support the vehicle securely with a jackstand.
2. Remove the front tire on the passenger's side for ease of access (optional).
3. Remove the fill plug.
4. Place a drain pan under the drain plug ② on the bottom right-hand side.
5. Remove the drain plug. Drain the oil.
6. Clean and reinstall the drain plug. Torque to specification.
7. Add the recommended fluid to the bottom of the fill plug hole. Do not overfill.
8. Reinstall the fill plug. Torque to specification.
9. Check for leaks.
10. Discard used oil properly.

SPARK PLUGS

SPARK PLUG RECOMMENDATIONS

Refer to the Specifications section for the recommended spark plug type for your vehicle. Always torque spark plugs to specification.

NOTICE

Using non-recommended spark plugs can result in serious engine damage. Always use POLARIS-recommended spark plugs or their equivalent.

SPARK PLUG GAP/TORQUE

| ELECTRODE GAP | NEW OR USED PLUG TORQUE |
|---------------|-------------------------|
| 0.7 – 0.8 mm | 9 (12 N·m) |

SPARK PLUG INSPECTION

Spark plug condition is indicative of engine operation. The spark plug firing end condition should be read after the engine is warmed up and the vehicle is driven at higher speeds. Immediately check the spark plug for correct color.

CAUTION

A hot exhaust system and engine can cause burns. Wear protective gloves when removing a spark plug for inspection.

To inspect the spark plugs, do the following:

1. Lift the cargo box to access the spark plugs.
2. Remove the spark plug cap. Using the spark plug wrench provided in the tool kit, remove the plug by rotating it counter-clockwise.
3. Reverse the procedure for spark plug installation.
4. Torque to specification.

NORMAL PLUG

The normal insulator tip is gray, tan or light brown. There will be few combustion deposits. The electrodes are not burned or eroded. This indicates the proper type and heat range for the engine and the service.

The tip should not be white. A white insulator tip indicates overheating, caused by use of an improper spark plug or incorrect throttle body adjustments.

MAINTENANCE

WET FOULED PLUG

The wet fouled insulator tip is black. A damp oil film covers the firing end. There may be a carbon layer over the entire nose. Generally, the electrodes are not worn. General causes of fouling are excessive oil, use of non-recommended oil or poor fuel quality.

COOLING SYSTEM

The engine coolant level is controlled or maintained by the recovery system. The recovery system components are the overflow bottle, radiator filler neck, radiator pressure cap and connecting hose.

As coolant operating temperature increases, the expanding (heated) excess coolant is forced out of the radiator, past the pressure cap, and into the overflow bottle. As engine coolant temperature decreases, the contracting (cooled) coolant is drawn back up from the tank, past the pressure cap, and into the radiator.

Some coolant level drop on new vehicles is normal as the system is purging itself of trapped air. Observe coolant levels and maintain as recommended by adding coolant to the overflow bottle.

ADDING OR CHANGING COOLANT

POLARIS recommends the use of POLARIS Antifreeze 50/50 Premix. This antifreeze is already premixed and ready to use. Do not dilute with water.

To ensure that the coolant maintains its ability to protect the engine, we recommend that the system be completely drained every five (5) years and fresh Antifreeze 50/50 Premix added.

Any time the cooling system has been drained for maintenance or repair, replace the coolant with fresh Antifreeze 50/50 Premix. If the recovery bottle has run dry, the level in the radiator should be inspected. Add coolant as needed.

RADIATOR AND COOLING FAN

Always check and clean the screen and radiator fins at the intervals outlined in the Periodic Maintenance Chart. Do not obstruct or deflect air flow through the radiator by installing unauthorized accessories in front of the radiator or behind the cooling fan. Interference with the radiator air flow can lead to overheating and consequent engine damage.

NOTICE

Washing the vehicle with a high-pressure hose could damage the radiator fins and impair the radiator's effectiveness. Using a high-pressure system is not recommended.

RADIATOR COOLANT LEVEL

Always check and clean the screen and radiator fins at the intervals outlined in the Periodic Maintenance Chart. Do not obstruct or deflect air flow through the radiator by installing unauthorized accessories in front of the radiator or behind the cooling fan. Interference with the radiator air flow can lead to overheating and consequentially, engine damage.

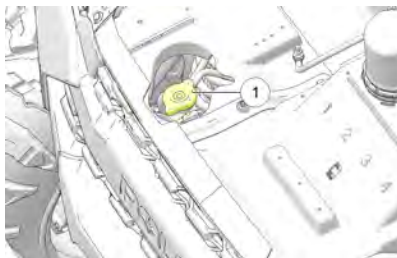

1. Lift the hood.

CAUTION

Escaping steam can cause burns. Never remove the pressure cap while the engine is warm or hot. Always allow the engine to cool before removing the pressure cap.

2. Slowly remove the radiator cap ①.
3. View the coolant level through the opening.
4. Use a funnel and slowly add coolant as needed.

TIP

This procedure is required only if the cooling system has been drained for maintenance and/or repair. But if the overflow bottle has run dry, the level in the radiator should also be inspected.

5. Reinstall the pressure cap. Use of a non-standard pressure cap will not allow the recovery system to function properly. Your POLARIS dealer can provide the correct replacement part.

MAINTENANCE

OVERFLOW BOTTLE COOLANT LEVEL

Always check and change the coolant at the intervals outlined in the Periodic Maintenance Chart. Maintain the coolant level between the minimum and maximum marks on the bottle (when the fluid is cool).

1. Position the vehicle on a level surface.
2. Lift the hood. View the coolant level in the overflow bottle ②.
3. If the coolant level is below the safe operating range, lift the hood and locate the overflow bottle lid. Remove the cap and use a funnel to add coolant through the filler opening. Reinstall the cap.

TIP

If coolant must be added often, or if the overflow bottle runs completely dry, there may be a leak in the system. Your dealer can inspect the cooling system.

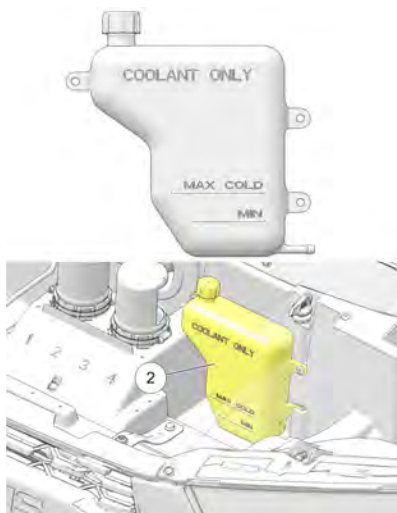

AIR CONDITIONING

⚠ WARNING

Only licensed and certified professionals are allowed to check and maintain AC refrigerant levels. Your POLARIS dealer can assist.

FILTER CLEANING

The air conditioning filter is located below the center hood.

1. Remove the two fasteners and remove the filter cover.
2. Clean the filter with low air pressure. Check for damage, replace if damaged.

CONDENSER CLEANING

NOTICE

Washing the vehicle with a high-pressure hose could damage the radiator fins and impair the radiator's effectiveness. Using a high-pressure system is not recommended.

The condenser should be cleaned at the correct service interval as outlined in the Periodic Maintenance Chart. The condenser is located at the front of the vehicle, behind the front grille.

To clean the condenser, do the following:

1. Stop the machine on a flat level surface. Place the gear selector in PARK. Stop the engine and exit the vehicle.
2. Remove the front grille of the vehicle by pushing down on the two grille tabs ① and pull the top of the grille toward the front of the vehicle.
3. Use low pressure air or water to clean the condenser.
4. Reinstall the front grille and ensure it is snapped into place.

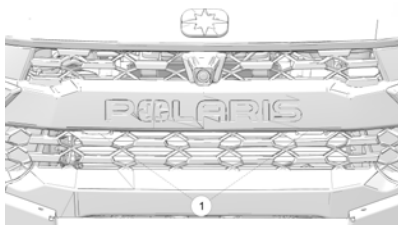

POLARIS VARIABLE TRANSMISSION (PVT) SYSTEM

WARNING

Failure to comply with the instructions in this warning can result in severe injury or death. Do not modify any component of the PVT system. Doing so may reduce its strength so that a failure may occur at a high speed. The PVT system has been precision balanced. Any modification will cause the system to be out of balance, creating vibration and additional loads on components.

The PVT system rotates at high speeds, creating large amounts of force on clutch components. As the owner, you have the following responsibilities for your own safety and the safety of others:

- Always follow all recommended maintenance procedures. Always look for and remove debris inside and around the clutch and vent system when replacing the belt.
- See your dealer or other qualified service person as outlined in the owner's manual.
- This PVT system is intended for use on POLARIS products only. Do not install it in any other product.
- Always make sure the PVT housing is securely in place during operation.

BELT REMOVAL

If a belt fails, always clean any debris from the clutch air duct and from the clutch and engine compartments when replacing the belt.

WARNING

Failure to remove ALL debris when replacing the belt could result in vehicle damage, loss of control and severe injury or death.

NOTICE

Inspect the entire clutch outlet duct (including the outlet duct screen) when replacing a drive belt. Remove any debris found in the outlet duct or outlet duct screen.

To remove the belt, do the following:

1. Remove the nine fasteners ① that retain the outer clutch cover.

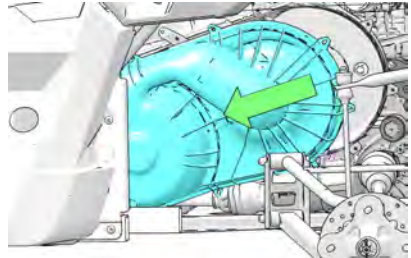
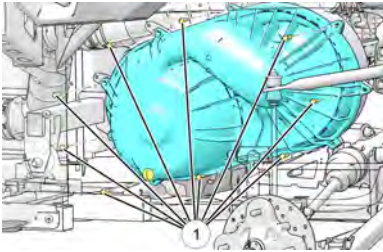

NOTICE

Removal of left rear wheel or left rear shock is NOT necessary for belt replacement.

2. Pull the clutch cover forward and slide towards the front of the vehicle as shown above.

MAINTENANCE

3. Rotate the clutch cover back and lift up and over the control arm mounting
②.

NOTICE

Use care when lifting clutch cover upwards. Do not damage cover, intake boot, or electrical harness.

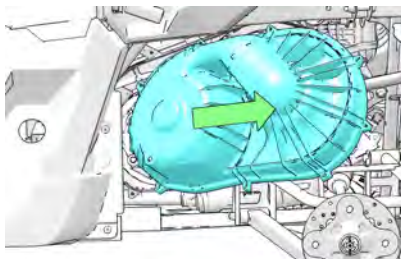
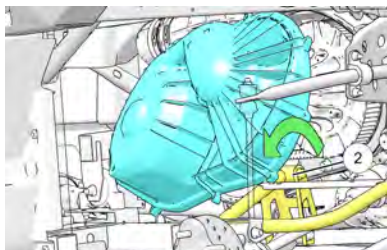

4. Pull clutch cover out towards the rear of the vehicle as shown above.
5. Mark the drive belt direction of rotation so that it can be installed in the same direction.
6. Insert clutch spreader tool ③ into threaded hole on driven clutch as shown and turn clockwise to spread clutch.

NOTICE

Clutch spreader tool part number 2875911 is found in vehicle tool kit.

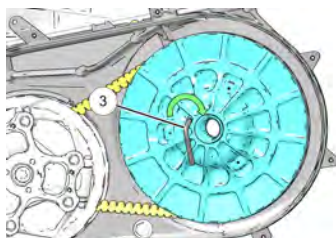

7. Walk the belt out of the driven clutch and drive clutch. Remove the belt from the vehicle.

BELT INSPECTION

To inspect the drive belt, do the following:

1. Inspect belt for hour-glassing (extreme circular wear in at least one spot and on both sides of the belt). Hour glassing occurs when the drive train does not move and the drive clutch engages the belt.
2. Inspect belt for loose cords, missing cogs, cracks, abrasions, thin spots, or excessive wear. Compare belt measurements with a new drive belt. Replace if necessary.
3. Belts with thin spots, burn marks, etc., should be replaced to eliminate noise, vibration, or erratic PVT operation.

BELT INSTALLATION

NOTICE

Be sure to install belt in the same direction as it was removed.

1. With the clutch spreader tool ① installed, loop the belt over the drive clutch and over the driven clutch.

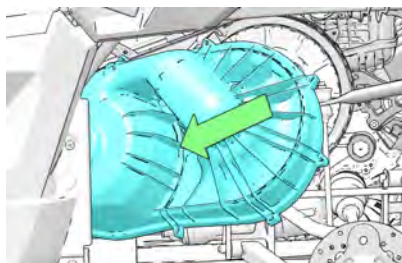
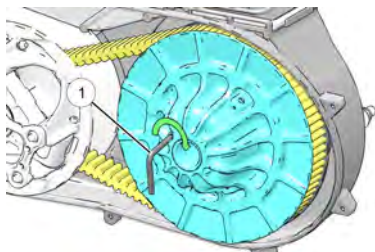

2. Rotate the driven clutch and walk the belt into the clutch.
3. Remove the clutch spreader tool from driven clutch.
4. Rotate / spin the driven clutch and belt approximately 5-7 times to properly seat the belt in the driven clutch.
5. Install the clutch cover into wheel well as shown above.
6. Rotate clutch cover over A-Arm ② as shown below. Use care not to damage intake boots or electrical harness.

MAINTENANCE

7. Pull clutch cover backwards and align with bolt holes on inner clutch cover as shown below.

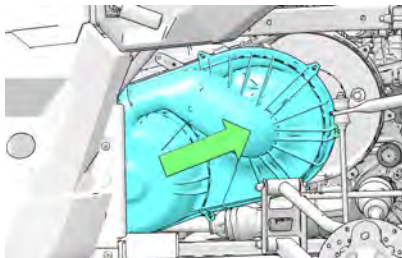
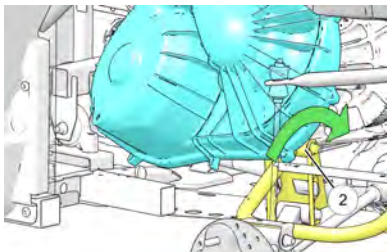

8. Install and torque the outer clutch cover bolts to specification.

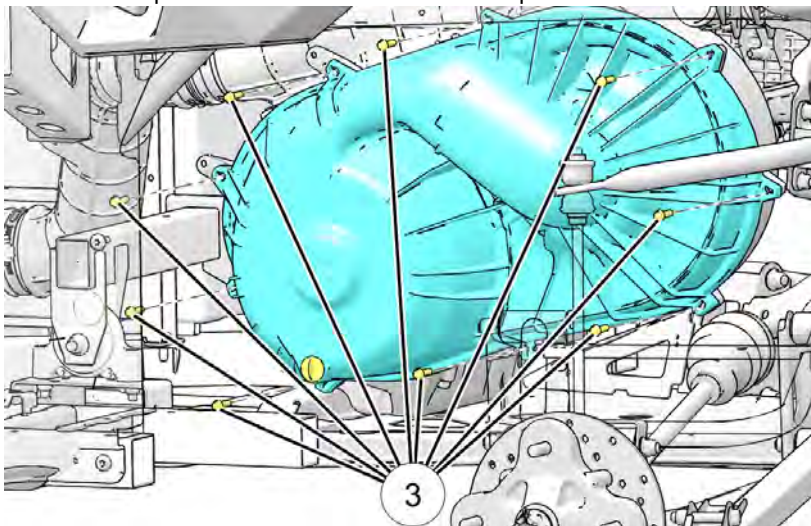

TORQUE

PVT Outer Cover Fasteners: **35 in-lbs (4 N·m)**

POLARIS VARIABLE TRANSMISSION (PVT) DRYING

There may be some instances when water is ingested into the PVT system. Use the following instructions to dry it out before operating:

1. Position the vehicle on a level surface.
2. Remove the red drain plug on the outer clutch cover. Allow the water to drain completely. Reinstall the drain plug.
3. Place the transmission in PARK.
4. Start the engine.
5. Apply varying throttle for 10-15 seconds to expel the moisture and air-dry the belt and clutches. Do not hold the throttle wide open for more than five (5) seconds.
6. Allow the engine RPM to settle to idle speed. Apply the brakes. Shift the transmission to the lowest available range.
7. Test for belt slippage. If the belt slips, repeat the process.
8. Your vehicle requires service as soon as possible. Your POLARIS dealer can assist.

VEHICLE IMMERSION

 **WARNING**

If your vehicle becomes immersed, major engine damage can result if the machine is not thoroughly inspected. Take the vehicle in for service before starting the engine. Your POLARIS dealer can provide this service.

If it's impossible to take your RANGER to a dealer before starting it, follow the steps outlined below:

1. Move the vehicle to dry land or at the very least, to water below the floorboard (or to water below seat base level if your vehicle is equipped with high mounted intakes).
2. Dry any water present in the air box. Filter replacement is required if water is present.
3. Remove the spark plugs. Turn the engine over several times using the electric start.
4. Dry the spark plugs and reinstall, or replace with new plugs.
5. Attempt to start the engine. If necessary, repeat the drying procedure.
6. Take the vehicle in for service as soon as possible, whether you succeed in starting it or not. Your POLARIS dealer can provide the required service.
7. If water has been ingested into the PVT follow the procedure for drying.

FILTER SYSTEMS

AIR FILTER REPLACEMENT

Inspect the air filter at the intervals outlined in the Periodic Maintenance Chart. In extremely dusty conditions, air filter replacement will be required more often.

1. Tilt the rear cargo box to access the airbox.
2. Release the five airbox cover latches and lift the cover up and out to access the air filter element.

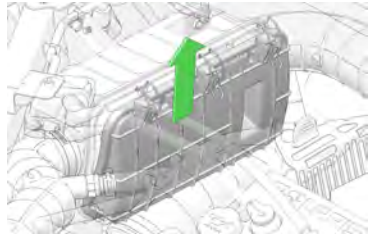
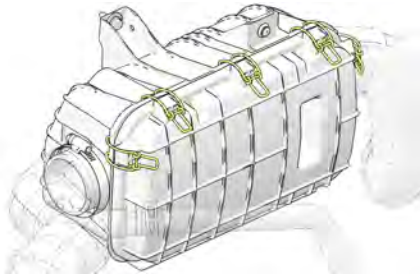

3. Remove the air filter element ①.

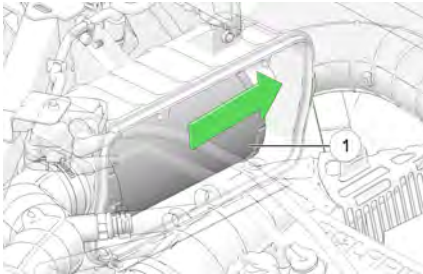

4. Inspect the airbox for oil or water deposits. Wipe away any deposits with a clean shop towel.

NOTICE

If the filter has been soaked with fuel or oil it must be replaced.
DO NOT attempt to clean the air filter.

5. Place the air filter into the airbox. Reposition the lower airbox cover and install the three retaining latches.

NOTICE

Make sure the hinge pins are properly seated when reassembling the airbox

MAINTENANCE

SPARK ARRESTER

WARNING

- Never operate the vehicle without the spark arrester.
- Remove any combustible materials from the area.

Failure to heed the following warnings while servicing the spark arrester could result in serious injury or death.

- Never run the engine in an enclosed area. Exhaust contains poisonous carbon monoxide gas that can cause loss of consciousness or death in a very short time.
- Do NOT perform service on the spark arrester while the system is HOT. Exhaust system temperatures can reach extreme temperatures. Allow components to cool sufficiently before proceeding.
- Do not stand behind or in front of the vehicle while purging the exhaust system.
- Never go under the vehicle while it is inclined.
- Wear eye protection and gloves while servicing.

Use the following procedure to periodically purge accumulated carbon from the exhaust pipe.

1. Turn off engine and allow exhaust to cool sufficiently.
2. Remove the spark arrester from the tailpipe of the muffler.
3. Remove any debris from spark arrester and the tailpipe.
4. Inspect spark arrester for holes in mesh screen. Replace as needed.
5. Replace spark arrester and torque bolt to specification.

TORQUE

Spark Arrester Bolt
10 ft-lbs (14 N·m)

BRAKES

The front and rear brakes are hydraulic disc type brakes. Press down on the brake pedal to engage the brakes.

BRAKE FLUID

Inspect the brake system routinely. Inspect the level of the brake fluid before each operation.

WARNING

After opening a bottle of brake fluid, always discard any unused portion. Never store or use a partial bottle. Brake fluid is hygroscopic, meaning it rapidly absorbs moisture from the air. The moisture causes the boiling temperature of the brake fluid to drop, which can lead to early brake fade and the possibility of accident or severe injury.

Change the brake fluid every two years and any time the fluid becomes contaminated, the fluid level is below the minimum, or if the type and brand of the fluid in the reservoir are unknown.

1. Position the vehicle on a level surface and turn off the engine.
2. View the brake fluid level ① at the reservoir in the driver's side wheel well. The level should be between the upper (MAX) and lower (MIN) level lines.

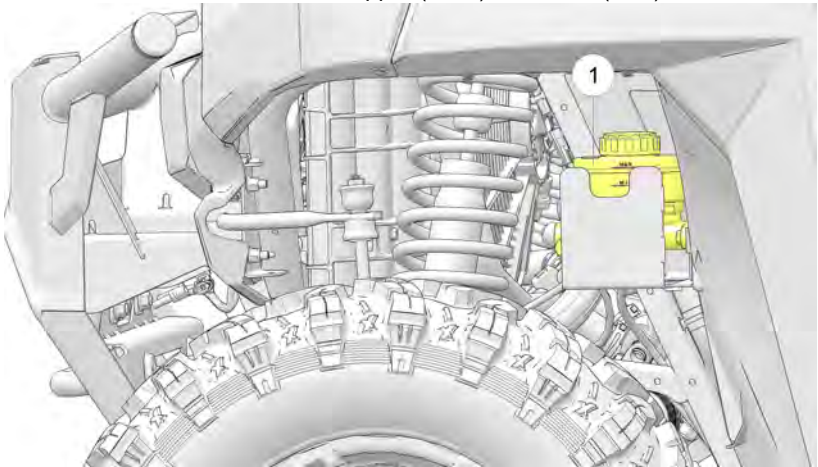

3. If the fluid level is lower than the upper level line, remove the master cylinder cap and add brake fluid to the upper (MAX) line.
4. Apply the brake forcefully for a few seconds and check for fluid leakage around the fittings.

MAINTENANCE

BRAKE INSPECTION

WARNING

Do not apply WD-40® or any petroleum product to brake discs. These types of products are flammable and may also reduce the friction between the brake pad and caliper.

WARNING

Brake components get hot with prolonged use and can cause burns. Wear protective gloves when inspecting the brakes.

1. Check the brake system for fluid leaks.
2. Check the brake pedal for excessive travel or a spongy feel.
3. Check the friction pads for wear, damage and looseness.
4. Check brake discs for signs of cracks, excessive corrosion, warping or other damage. Clean any grease using an approved brake cleaner or alcohol.
5. Inspect the brake disc spline and pad wear surface  for excessive wear. Change pads when worn to 0.030" (0.762 mm).

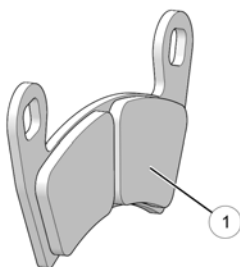

STEERING WHEEL INSPECTION

Check the steering wheel for specified freeplay and smooth operation at the intervals outlined in the Periodic Maintenance Chart section.

1. Position the vehicle on level ground.
2. Lightly turn the steering wheel left and right.
3. There should be 0.8-1.0 in (20-25 mm) of freeplay.
4. If there is excessive freeplay or strange noises, or the steering feels rough or “catchy,” have the steering system inspected by an authorized dealer.

SUSPENSION ADJUSTMENT

The front and rear suspensions can be adjusted to provide a stiffer suspension, if necessary.

1. Remove the top shock mounting bolts from the inside mounting positions ①.
2. Reposition the shocks to the outside mounting holes ②.
3. Reinstall the shock mounting bolts. Torque to 40 (54).

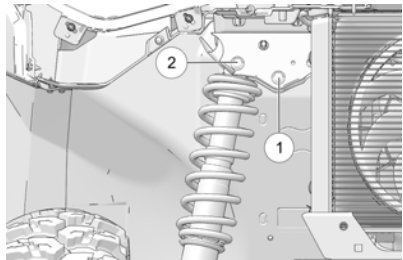

MAINTENANCE

CAM ADJUSTMENT

NOTICE

Trail Boss and NorthStar Trail Boss models are equipped with Nivomat shocks, which cannot be manually adjusted. Nivomat shocks automatically adjust internal pressure during use

Adjust the front and rear shock absorber springs by rotating the adjustment cam either clockwise or counter-clockwise to increase or decrease spring tension.

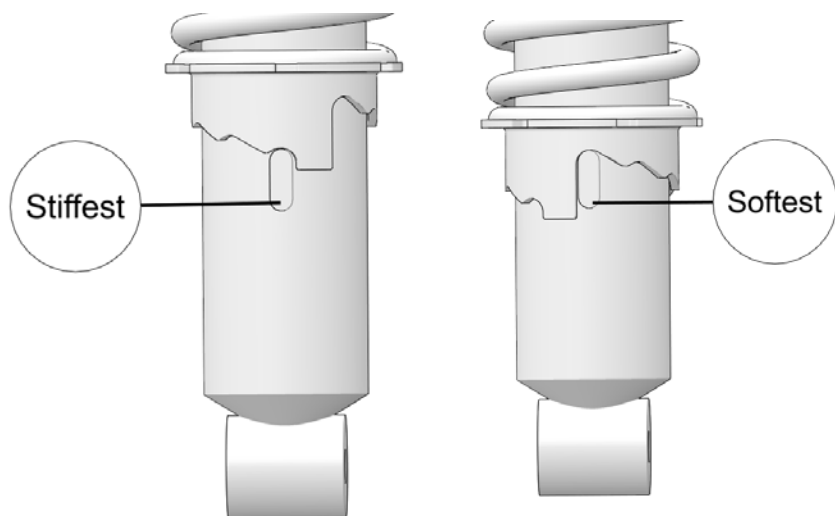

Always heed the following rules if you make adjustments to this suspension.

- Always return the suspension to the lowest (softest) setting after the load is removed from the vehicle. The increased suspension height will negatively impact vehicle stability when operating without a load.
- Always apply the same adjustment setting to both rear wheels.

TIRES

⚠ WARNING

Operating your vehicle with worn tires will increase the possibility of skidding, loss of control and an accident, which could result in serious injury or death.

Always replace tires when the tread depth measures 1/8 in (3 mm) or less.

Improper tire inflation or the use of non-standard size or type of tires may adversely affect vehicle handling, which could result in vehicle damage or personal injury. Always maintain proper tire pressure. Always use POLARIS approved size and type of tires for this vehicle when replacing tires.

TIRE TREAD DEPTH

Always replace tires when tread depth is worn to 3 mm (1/8") or less.

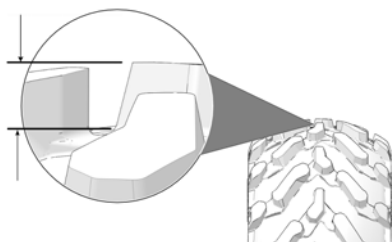

AXLE AND WHEEL NUT TORQUE SPECIFICATIONS

Inspect the following items occasionally for tightness, and if they've been loosened for maintenance service. Do not lubricate the stud or the lug nut.

| | | |
|--|----------------|----------------------------------|
| Lug Nut (Aluminum Wheels)  | Front and Rear | 120 (163) 120 ft-lbs (163 Nm) |
| Spindle Nut | Front | 180 (245) |
| Hub Retaining Nut | Rear | 180 (245) |

MAINTENANCE

WHEEL REMOVAL

1. Position the vehicle on a level surface.
2. Apply the brakes. Set the park brake. Turn the key off.
3. Loosen the wheel nuts slightly.
4. Elevate the side of the vehicle by placing a suitable stand under the frame.
5. Remove the wheel nuts. Remove the wheel.

WHEEL INSTALLATION

 **WARNING**

Improperly installed wheels can adversely affect tire wear and vehicle handling, which can result in serious injury or death. Always ensure that all nuts are torqued to specification. Do not service axle nuts that have a cotter pin installed. Your dealer can assist.

1. Place the transmission in **PARK**.
2. Place the wheel on the hub with the valve stem toward the outside and rotation arrows on the tire pointing toward forward rotation.
3. Attach the wheel nuts and finger-tighten.
4. Carefully lower the vehicle to the ground.
5. Torque the wheel nuts to specification.

LED LIGHTS (IF EQUIPPED)

LIGHTS

Poor lighting can result in reduced visibility when driving. Headlight and taillight lenses become dirty during normal operation. Clean lights frequently and replace failed (or failing) lights promptly. Do not operate this vehicle at night or in low light conditions until the headlight is replaced. Always make sure lights are adjusted properly for best visibility.

The vehicle is equipped with integrated LED lights. In the event of a failure, the entire assembly^① must be replaced.

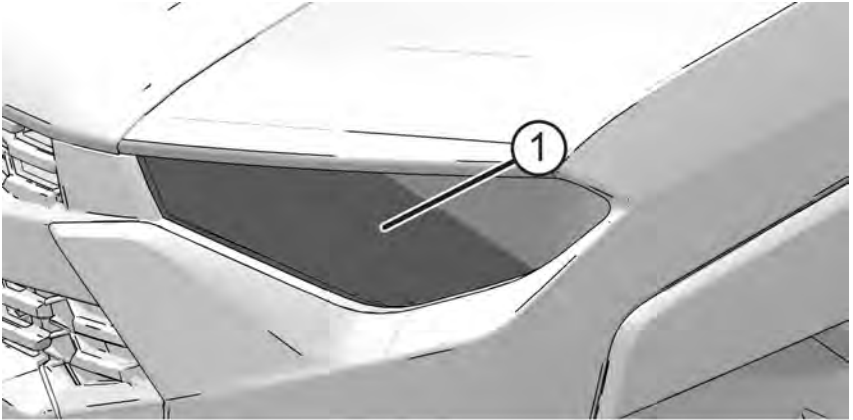

HALOGEN LIGHTS (IF EQUIPPED)

LIGHTS

Poor lighting can result in reduced visibility when driving. Headlight and taillight lenses become dirty during normal operation. Clean lights frequently and replace burned out lamps promptly. Do not operate this vehicle at night or in low light conditions until the headlight is replaced. Always make sure lights are adjusted properly for best visibility.

When servicing a halogen lamp, don't touch the lamp with bare fingers. Oil from your skin leaves a residue, causing a hot spot that will shorten the life of the lamp.

HEADLIGHT BULB REPLACEMENT

1. Remove the hood from the front cab.
2. Locate the bulb on the back side of the headlight housing.
3. Disconnect the harness from the bulb. Be sure to pull on the connector ①, not on the wiring.

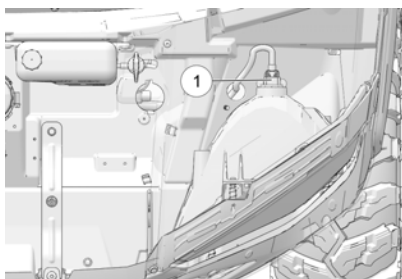

4. Turn the bulb counterclockwise and remove it from the headlight housing, as shown above.
5. Install the new bulb into the housing and rotate it clockwise 90° to lock it in place.

NOTICE

Make sure the tab on the bulb locates properly in the housing.

6. Install the harness onto the new headlight bulb and install the hood.

HEADLIGHT BEAM ADJUSTMENT

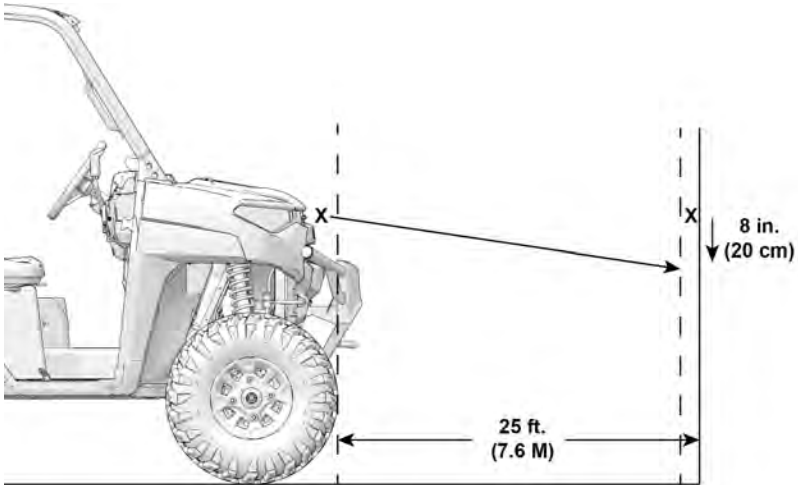

To adjust the headlight beam, do the following:

1. Ensure the tire pressure of all tires is at recommended levels.
2. Place the vehicle on a level surface with the headlight approximately 25 ft. (7.6 m) from a dark wall.
3. Measure the distance from the floor to the center of the headlight and make a mark on the wall at the same height.
4. Apply the brakes. Start the engine. Turn on the low-beam headlights.
5. Observe the headlight aim. The most intense part of the headlight beam should be aimed 8" (20 cm) below the mark placed on the wall. Include the weight of a rider on the seat while performing this step.
6. If a headlight needs adjustment, locate the three adjustment screws at the back of each headlight (one on top, two on the bottom).
7. Rotate the adjustment screw to adjust the headlight as needed.

BRAKE LIGHTS

When the brake pedal is depressed, the brake light comes on. Check the brake light before each ride.

To check the brake lights, do the following:

MAINTENANCE

1. Turn the key to the ON position.
2. Depress the brake pedal. The brake light should come on after about 0.4 in (10 mm) of pedal travel. If the light doesn't come on, check the bulb.

FUSES

If the engine stops or will not start, or if you experience other electrical failures, a fuse may need replacement. Locate and correct any short circuits that may have caused the blown fuse, then replace the fuse. To access the fuse box, remove the storage bin under the center rear-most seat. Spare fuses are provided in the fuse box. If you suspect that a fuse or relay may not be working properly, your dealer can assist.

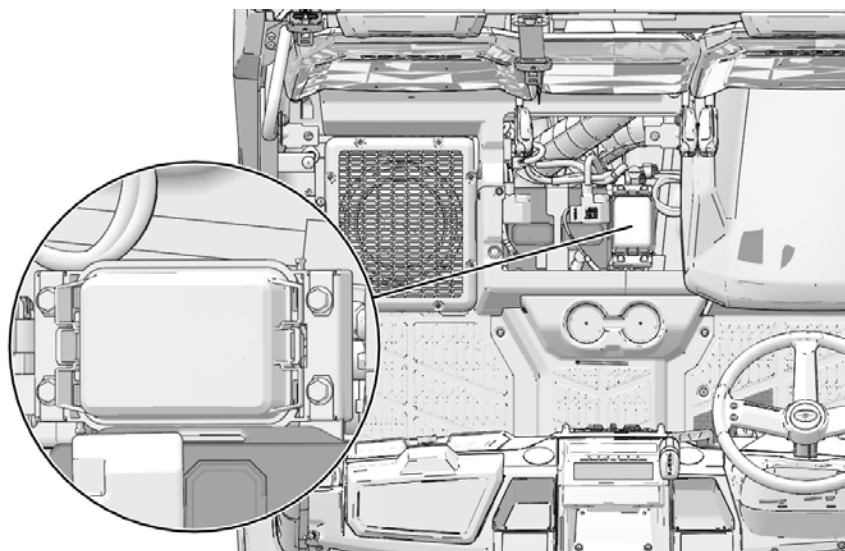

PREMIUM / CREW, HD, AND MD CREW MODELS

| FUSE SIZE | FEATURE SUPPORTED |
|-----------|-------------------|
| 20A | Accessory |
| 15A | Lights |
| 7.5A | Winch |
| 10A | Key Switch |
| 10A | Trickle Charge |
| 15A | Drive |
| 7.5A | Display |
| 20A | Chassis |
| 30A | EPS |

MAINTENANCE

| FUSE SIZE | FEATURE SUPPORTED |
|---------------------|----------------------------|
| 10A | ECM |
| 20A Circuit Breaker | Fan |
| 20A | Box Power (HD Models Only) |

NORTHSTAR PREMIUM / CREW, NORTHSTAR TRAIL BOSS / CREW, TEXAS EDITION, AND NORTHSTAR ULTIMATE / CREW MODELS

NorthStar models come equipped with an external 50A fuse^① for the fan. The fuse is located on the battery tray.

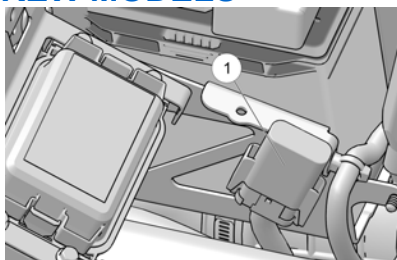

| FUSE SIZE | FEATURE SUPPORTED |
|-----------|-------------------|
| 7.5A | Winch |
| 10A | ECM |
| 30A | EPS |
| 20A | Accessory |
| 15A | Drive |
| 20A | Chassis |
| 15A | Alternator (S) |
| 15A | Alternator (L) |
| 20A | Amp |
| 10A | Key Switch |
| 7.5A | Display |
| 30A | HVAC |
| 7.5A | HVAC 2 |

MAINTENANCE

| FUSE SIZE | FEATURE SUPPORTED |
|------------------|--------------------------|
| 15A | Lights |
| 10A | Trickle Charge |
| 20A | Box Power |
| 50A | Fan |

BATTERY

 **WARNING**

Battery electrolyte is poisonous. It contains sulfuric acid. Serious burns can result from contact with skin, eyes or clothing.

Antidote:

External: Flush with water.

Internal: Drink large quantities of water or milk. Follow with milk of magnesia, beaten egg, or vegetable oil. Call physician immediately.

Eyes: Flush with water for 15 minutes and get prompt medical attention.

Batteries produce explosive gases. Keep sparks, flame, cigarettes, etc. away. Ventilate when charging or using in an enclosed space. Always shield eyes when working near batteries. **KEEP OUT OF REACH OF CHILDREN.**

Your vehicle has a low-maintenance flooded battery. It does not require refilling.

Always keep battery terminals and connections free of corrosion. If cleaning is necessary, remove the corrosion with a stiff wire brush. Wash with a solution of one tablespoon baking soda and one cup water. Rinse well with tap water and dry off with clean shop towels. Coat the terminals with dielectric grease or petroleum jelly. Be careful not to allow cleaning solution or tap water into a conventional battery.

 **WARNING**

Improperly connecting or disconnecting battery cables can result in an explosion and cause serious injury or death. When removing the battery, always disconnect the negative (black) cable first. When reinstalling the battery, always connect the negative (black) cable last.

BATTERY MAINTENANCE AND CHARGING

WARNING

An overheated battery may explode, causing severe injury or death. Always watch charging times carefully. Stop charging if the battery becomes very warm to the touch. Allow it to cool before resuming charging.

The sealed battery is already filled with electrolyte and has been sealed and *fully charged* at the factory. *Never* pry the sealing strip off or add any other fluid to this battery.

The single most important thing about maintaining a sealed battery is to keep it fully charged. Check the battery voltage with a voltmeter or multimeter. A fully charged battery will register 12.8 V or higher. If the voltage falls below 12.5V, charge it immediately, or the battery runs the risk of sulfation and reduced battery life.

If you do not drive the vehicle for more than TWO WEEKS, Polaris recommends using a BatteryMINDER® 2012 AGM - 2 AMP charger (PN 2830438), which can be ordered through your dealer.

Polaris provides a charging accessory with your vehicle that allows easy connection to the battery through the 12V auxiliary outlet, located on the dash. During charging, place the charger outside of the vehicle and protect it from moisture.

IMPORTANT

The 12V socket located in the rear of 4 seat vehicles is powered after key-on and **CANNOT** be used for charging.

If you plan to store the vehicle for ONE MONTH or longer, remove the battery from the vehicle, then store the battery in a cool and dry location. Continue to maintain the battery with the BatteryMINDER® 2012 AGM - 2 AMP charger.

When using an automatic charger other than a BatteryMINDER® 2012-AGM - 2 AMP charger, refer to the charger manufacturer's instructions for recharging.

If using a **constant current charger** (instead of BatteryMINDER® 2012 AGM - 2 AMP charger), use the guidelines below. Always verify battery condition before and 1-2 hours after the end of charging.

MAINTENANCE

| STATE OF CHARGE | VOLTAGE (DC) | ACTION | CHARGE TIME* |
|-----------------|--------------------|--|-------------------|
| 100% | 12.8-13.0 volts | None, check monthly | None required |
| 75%-100% | 12.6-12.8 volts | May need slight charge, if no charge given, check in 2 weeks | 3-6 hours |
| 50%-75% | 12.3-12.6 volts | Needs charge | 5-11 hours |
| 25%-50% | 12.0-12.3 volts | Needs charge | At least 13 hours |
| 0%-25% | 12.0 volts or less | Needs charge | At least 20 hours |

* Using AGM specific charger at standard amps specified on top of battery

BATTERY REMOVAL

WARNING

Improperly connecting or disconnecting battery cables can result in an explosion and cause serious injury or death. When removing the battery, always disconnect the negative (black) cable first. When reinstalling the battery, always connect the negative (black) cable last.

To remove the battery, do the following:

1. Remove the storage bin under the center rear-most seat to access the battery.
2. Disconnect the black (-) battery cable first. Disconnect the red (+) battery cable last.
3. Remove the battery hold-down strap.
4. Lift the battery out of the vehicle. Be careful not to tip a flooded battery sideways, which could spill electrolyte.

NOTICE

If electrolyte spills, immediately wash it off with a solution of one tablespoon baking soda and one cup water to prevent damage to the vehicle.

BATTERY INSTALLATION

1. Ensure that the battery is fully charged.
2. Place the battery in the battery holder.
3. Coat the terminals with dielectric grease or petroleum jelly.
4. Connect and tighten the red (positive) cable first.
5. Connect and tighten the black (negative) cable last.
6. Install the battery hold-down strap and tighten the screws.
7. Verify that cables are properly routed.
8. Reinstall the seat.

BATTERY STORAGE

Whenever the vehicle is not used for a period of three months or more, remove the battery from the vehicle, ensure that it's fully charged, and store it out of the sun in a cool, dry place. Check battery voltage each month during storage and recharge as needed to maintain a full charge.

TIP

Battery charge can be maintained by using a Polaris battery trickle charger or by charging about once a month to make up for normal self discharge. The battery trickle charger can be left connected during the storage period, and will automatically charge the battery if the voltage drops below a predetermined point.

CLEANING AND STORAGE

WASHING THE VEHICLE

Keeping your POLARIS vehicle clean will not only improve its appearance but it can also extend the life of various components.

NOTICE

High water pressure may damage components. POLARIS recommends washing the vehicle by hand or with a garden hose, using mild soap.

NOTICE

Certain products, including insect repellents and chemicals, will damage plastic surfaces. Do not allow these types of products to contact the vehicle.

The best and safest way to clean your POLARIS vehicle is with a garden hose and a pail of mild soap and water.

1. Use a professional-type washing cloth, cleaning the upper body first and the lower parts last.
2. Rinse with clean water frequently.
3. Dry surfaces with a chamois to prevent water spots.

WASHING TIPS

- Avoid the use of harsh cleaners, which can scratch the finish.
- Do not use medium to heavy duty compounds on the finish.
- Always use clean cloths and pads for cleaning and polishing. Old or reused cloths and pads may contain dirt particles that will scratch the finish.
- Grease all zerk fittings immediately after washing. Allow the engine to run for a while to evaporate any water that may have entered the engine or exhaust system.

If a high pressure water system is used for cleaning, exercise extreme caution. The maximum pressure should not exceed 4000 PSI, 2.5 GPM with a 40° pressure washer nozzle. Make sure to keep the pressure washer nozzle 23.6 in (60 cm) from the vehicle. The water may damage components and could remove paint and labels. Avoid directing the water stream at the following items:

- Wheel bearings
- Radiator
- Transmission seals
- Brakes
- Door seals (if equipped)
- Cab and body panels
- Labels and decals
- Electrical components and wiring
- Air intake components
- Window seals (if equipped)
- Throttle and shift cables and controls

If an informational or graphic label becomes illegible or comes off, contact your POLARIS dealer, or other qualified person, to purchase a replacement. Replacement safety labels are provided by POLARIS at no charge.

STORAGE TIPS

NOTICE

Starting the engine during the storage period will disturb the protective film created by fogging and damage could occur. Never start the engine during the storage period.

CLEAN THE EXTERIOR

Make any necessary repairs and clean the vehicle as recommended.

STABILIZE THE FUEL

1. Fill the fuel tank.
2. Add POLARIS Carbon Clean Fuel Treatment or POLARIS Fuel Stabilizer or equivalent fuel treatments or stabilizers. Follow the instructions on the container for the recommended amount. Carbon Clean removes water from fuel systems, stabilizes fuel and removes carbon deposits from pistons, rings, valves and exhaust systems.
3. Allow the engine to run for 15-20 minutes to allow the stabilizer to disperse through the entire fuel delivery system.

OIL AND FILTER

Change the oil and filter. See the Engine Oil section.

AIR FILTER / AIR BOX

Replace the air filter. See Maintenance Chapter. Clean the air box.

FLUID LEVELS

Inspect the fluid levels. Add or change fluids as recommended in the Periodic Maintenance Chart.

- Demand drive fluid (front gearcase)
- Rear gearcase fluid (if equipped)
- Transmission fluid
- Brake fluid (change every two years and any time the fluid looks dark or contaminated)
- Coolant (test strength/fill)

MAINTENANCE

INSPECT AND LUBRICATE

Inspect all cables and lubricate all areas of the vehicle as recommended in the Periodic Maintenance Chart.

FOG THE ENGINE

1. Treat the fuel system with POLARIS Carbon Clean or other equivalent fuel treatment. Follow the instructions on the container. Start the engine. Allow it to idle for several minutes so the Carbon Clean reaches the injectors. Stop the engine.
2. Remove the spark plugs and add 1–1.5 oz. (29.5–44 cc.) of engine oil. To access the plug holes, use a section of clear 6 mm (1/4") hose and a small plastic squeeze bottle filled with the pre-measured amount of oil. *Do this carefully! If you miss the plug holes, oil will drain from the spark plug cavities into the hole at the front of the cylinder head, and appear to be an oil leak.*
3. Reinstall the spark plugs. Torque to specification.
4. Apply dielectric grease to the inside of each spark plug cap. *Do not reinstall the cap onto the plug at this step.*
5. Turn the engine over several times. Oil will be forced in and around the piston rings and ring lands, coating the cylinder with a protective film of fresh oil.
6. Reinstall the spark plug caps.
7. If POLARIS fuel system additive is not used, fuel tank, fuel lines, and injectors should be completely drained of gasoline.

STORAGE AREA / COVERS

Be sure the storage area is well ventilated. Cover the vehicle with a genuine POLARIS cover. Do not use plastic or coated materials. They do not allow enough ventilation to prevent condensation, and may promote corrosion and oxidation.

REMOVAL FROM STORAGE

WARNING

Engine exhaust contains poisonous carbon monoxide and can cause loss of consciousness or death. Never run an engine in an enclosed area.

1. Check the battery electrolyte level and charge the battery if necessary. Install it in the vehicle. Make sure the battery vent hose is routed properly and that it's not pinched or restricted in any way.
2. Make sure spark plugs are tight.
3. Fill the fuel tank with fuel.
4. Check all the points listed in the Daily Pre-Ride Inspection. *Tightness of the bolts, nuts and other fasteners should be checked by an authorized dealer or other qualified service facility.*
5. Lubricate at the intervals outlined in the Periodic Maintenance Chart.

TRANSPORTING THE VEHICLE

Follow these procedures when transporting the vehicle.

1. Apply the brakes.
2. Place the transmission in PARK. Stop the engine.
3. Slowly release the brake pedal and make sure the transmission is in PARK before exiting the vehicle.
4. Remove the key to prevent loss during transporting.
5. Secure the fuel cap and seat. Ensure that the seat is attached correctly and is not loose.

WARNING

Cargo and other loose vehicle parts may fly off while transporting this vehicle. Secure or remove all cargo, and inspect the unit for loose parts prior to transport.

If transporting the vehicle in a non-enclosed trailer, then the vehicle must FACE FORWARD, or roof must be removed.

Failure to comply may allow airflow, vibration, or other factors to separate the roof from the vehicle and cause an accident, resulting in serious personal injury or death.

6. Using suitable straps or rope, always secure the vehicle to the trailer using the designated tie down points (front and rear).

MAINTENANCE

Front Tie-Down Location

- ① Front tie-down points



Rear Tie-Down Locations

- ② Rear tie-down points

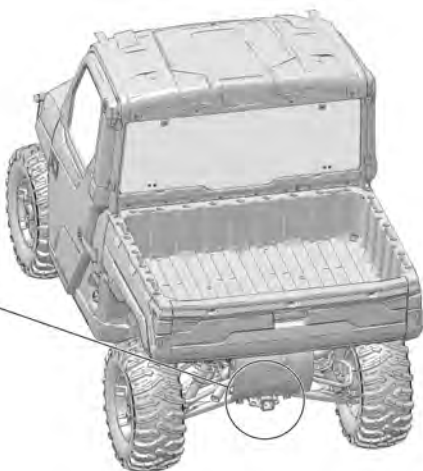
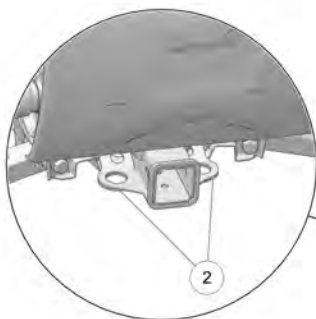

SPECIFICATIONS

RANGER XP 1000 PREMIUM / HD

RANGER CREW XP 1000 PREMIUM / MD

| DESCRIPTION | SPECIFICATION |
|--|---|
| Maximum Weight Capacity (includes weight of operator, passenger, cargo, accessories) | 1500 lb (680 kg) CA Models: 1100 lb (499 kg) HD Models: 1500 lb (680 kg) CREW: 1690 lb (767 kg) CREW CA Models: 1350 lb (612 kg) CREW MD Models: 1690 lb (767 kg) |
| Dry Weight* | 1625 lb (737 kg) CREW: 1894 (859 kg) |
| Test GVW - Rollover Protection System (ROPS) | 3600 lbs. (1633 kg) per OSHA® 29 CFR 1928.53 CREW: 3750 lbs. (1701 kg) per OSHA® 29 CFR 1928.53 |
| Fuel Capacity | 11.5 gal (43.5 L) |
| Engine Oil Capacity | 2.5 qt (2.4 L) |
| Coolant Capacity | 5 qt (4.75 L) CREW: 5.65 qt (5.35 L) |
| Overall Length | 120 in (305 cm) CREW: 152 in (386 cm) |
| Overall Width | 62.5 in (158 cm) |
| Overall Height | 77 in (196 cm) |
| Wheelbase | 81 in (206 cm) CREW: 113 in (287 cm) |
| Cargo Box Dimensions (Inside) | 36.75 x 54.25 x 12.5 in (93 x 138 x 32 cm) |
| Ground Clearance | 13 in (33 cm) |
| Min. Turning Radius | 156 in (396 cm) |
| Towing Capacity | 2500 lb (1134 kg) |
| Hitch Tongue Capacity | 250 lb (113 kg) |

SPECIFICATIONS

| DESCRIPTION | SPECIFICATION |
|--------------------------|--|
| Max. Cargo Box Load | 1000 lb (454 kg) CA Models: 600 lb (272 kg) |
| Engine | 4-Stroke DOHC Twin Cylinder |
| Displacement | 999 cc |
| Bore x Stroke (mm) | 93 mm x 73.5 mm |
| Stator Output | 660 W @ 3000 RPM |
| Compression Ratio | 10.8:1 |
| Starting System | Electric |
| Fuel System | Electronic Fuel Injection |
| Ignition Timing | ECU Controlled 32° +/- 2° @ 5000 RPM |
| Spark Plug/ Gap | MR7F / 0.7-0.8 mm |
| Lubrication System | Wet Sump |
| Cooling | Liquid |
| Front Suspension | Dual A-Arm 11.0 in (27.9 cm) Travel |
| Rear Suspension | Dual A-Arm, IRS 11.0" (27.9 cm) Travel |
| Ignition System | Digital CDI |
| Driving System Type | Pro-PVT |
| Shift Type | Single Lever (H/L/N/R/P) |
| Gear Reduction - Low | Front 9.65:1/ Rear 28.84:1 |
| Gear Reduction - Reverse | Front 9.16:1 / Rear 27.39:1 |
| Gear Reduction - High | Front 4.35:1 / Rear 13.01:1 |
| Drive Ratio - Front | 3.23:1 |
| Tire Size - Front | 27 x 9-14; PRO ARMOR® X-TERRAIN |

SPECIFICATIONS

| DESCRIPTION | SPECIFICATION |
|-----------------------|--|
| Tire Size - Rear | 27 x 11-14; PRO ARMOR® X-TERRAIN |
| Tire Pressure - Front | 12 psi (83 kPa) CREW: 18 psi (124 kPa) HD: 10 psi (69 kPa) MD CREW: 14 psi (96 kPa) |
| Tire Pressure - Rear | 14 psi (97 kPa) CREW: 20 psi (138 kPa) HD: 14 psi (96 kPa) MD CREW: 16 psi (110 kPa) |
| Brakes, Front/Rear | Foot Activated, 4 wheel hydraulic disc with dual-bore front calipers |
| Hood Headlights | Halogen 55W Low Beam 60W High Beam |
| Taillights | LED |
| Brake Light | LED |

**Dry weight is also listed on the Certificate of Origin for your vehicle in the Shipping Weight field. The dry weight is estimated based on the manufactured weight of the vehicle minus any serviceable fluids and may also exclude the weight of factory installed accessories not essential to the vehicle's basic operation as outlined in the ANSI®/ROHVA® 1-2016 standard.*

CARBON DIOXIDE EMISSIONS

CO2 Emissions: 1011 g/kWh*

*This CO2 measurement results from testing over a fixed test cycle under laboratory conditions a(n) (parent) engine representative of the engine type (engine family) and shall not imply or express any guarantee of the performance of a particular engine'

SPECIFICATIONS

RANGER / CREW XP 1000 NORTHSTAR EDITION PREMIUM

| DESCRIPTION | SPECIFICATION |
|--|---|
| Maximum Weight Capacity (includes weight of operator, passenger, cargo, accessories) | 1275 lb (578 kg) CA Models: 1100 lb (499 kg) CREW: 1230 lb (558 kg) |
| Dry Weight* | 1913 lb (868 kg) CREW: 2344 lb (1063 kg) |
| Test GVW - Rollover Protection System (ROPS) | 3600 lb (1633 kg) per OSHA® 29 CFR 1928.53 CREW: 3750 lb (1701 kg) per OSHA® 29 CFR 1928.53 |
| Fuel Capacity | 11.5 gal (43.5 L) |
| Engine Oil Capacity | 2.5 qt (2.4 L) |
| Coolant Capacity | 5.5 qt (5.2 L) CREW: 6.25 qt (5.9 L) |
| Overall Length | 120 in (305 cm) CREW: 152 in (386 cm) |
| Overall Width | 65 in (165 cm) |
| Overall Height | 78 in (198 cm) |
| Wheelbase | 81 in (206 cm) CREW: 113 in (287 cm) |
| Cargo Box Dimensions (Inside) | 36.75 x 54.25 x 12.5 in (93 x 138 x 32 cm) |
| Ground Clearance | 13 in (33 cm) |
| Min. Turning Radius | 156 in (396 cm) |
| Towing Capacity | 2500 lb (1133 kg) |
| Hitch Tongue Capacity | 250 lb (113 kg) |
| Max. Cargo Box Load | 1000 lb (454 kg) CA Model: 600 lb (272 kg) |

SPECIFICATIONS

| DESCRIPTION | SPECIFICATION |
|--------------------------|--|
| Engine | 4-Stroke DOHC Twin Cylinder |
| Displacement | 999 cc |
| Bore x Stroke (mm) | 93 mm x 73.6 mm |
| Alternator Output | 1456W @ 5000 RPM |
| Compression Ratio | 10.8:1 |
| Starting System | Electric |
| Fuel System | Electronic Fuel Injection |
| Ignition Timing | ECU Controlled 32° +/- 2° @ 5000 RPM |
| Spark Plug/ Gap | MR7F / 0.7-0.8 mm |
| Lubrication System | Wet Sump |
| Cooling | Liquid |
| Front Suspension | Dual A-Arm 11.0 in (27.9 cm) Travel |
| Rear Suspension | Dual A-Arm, IRS 11.0 in (27.9 cm) Travel |
| Ignition System | Digital CDI |
| Driving System Type | Pro-PVT |
| Shift Type | Single Lever (H/L/N/R/P) |
| Gear Reduction - Low | Front 9.65:1 / Rear 28.84:1 |
| Gear Reduction - Reverse | Front 9.16:1 / Rear 27.39:1 |
| Gear Reduction - High | Front 4.35:1 / Rear 13.01:1 |
| Drive Ratio - Front | 3.23:1 |
| Tire Size - Front | 27 x 9-14; PRO ARMOR® X-TERRAIN |
| Tire Size - Rear | 27 x 11-14; PRO ARMOR® X-TERRAIN |

SPECIFICATIONS

| DESCRIPTION | SPECIFICATION |
|-----------------------|--|
| Tire Pressure - Front | 12 psi (83 kPa) CREW: 18 psi (124 kPa) |
| Tire Pressure - Rear | 14 psi (97 kPa) CREW: 20 psi (138 kPa) |
| Brakes, Front/Rear | Foot Activated, 4 wheel hydraulic disc with dual-bore front calipers |
| Hood Headlights | LED - replace entire assembly if fault occurs |
| Taillights | LED |
| Brake Light | LED |

**Dry weight is also listed on the Certificate of Origin for your vehicle in the Shipping Weight field. The dry weight is estimated based on the manufactured weight of the vehicle minus any serviceable fluids and may also exclude the weight of factory installed accessories not essential to the vehicle's basic operation as outlined in the ANSI®/ROHVA® 1-2016 standard.*

RANGER / CREW XP 1000 NORTHSTAR EDITION ULTIMATE

| DESCRIPTION | SPECIFICATION |
|--|--|
| Maximum Weight Capacity (includes weight of operator, passenger, cargo, accessories) | 1275 lb (578 kg) CA Models: 1100 lb (499 kg) CREW: 1150 lb (522 kg) |
| Dry Weight* | 1949 lb (884 kg) CREW: 2387 lb (1083 kg) |
| Test GVW - Rollover Protection System (ROPS) | 3600 lb (1633 kg) per OSHA® 29 CFR 1928.53 3750 lb (1701 kg) per OSHA® 29 CFR 1928.53 |
| Fuel Capacity | 11.5 gal (43.5 L) |
| Engine Oil Capacity | 2.5 qt (2.4 L) |
| Coolant Capacity | 5.5 qt (5.2 L) CREW: 6.25 qt (5.9 L) |
| Overall Length | 120 in (305 cm) CREW: 152 in (386 cm) |
| Overall Width | 65 in (165 cm) |
| Overall Height | 79.5 in (198 cm) |
| Wheelbase | 81 in (206 cm) CREW: 113 in (287 cm) |
| Cargo Box Dimensions (Inside) | 36.75 x 54.25 x 12.5 in (93 x 138 x 32 cm) |
| Ground Clearance | 14 in (36 cm) |
| Min. Turning Radius | 156 in (396 cm) |
| Towing Capacity | 2500 lb (1133 kg) |
| Hitch Tongue Capacity | 250 lb (113 kg) |
| Max. Cargo Box Load | 1000 lb (454 kg) CA Model: 600 lb (272 kg) |

SPECIFICATIONS

| DESCRIPTION | SPECIFICATION |
|--------------------------|---|
| Engine | 4-Stroke DOHC Twin Cylinder |
| Displacement | 999 cc |
| Bore x Stroke (mm) | 93 mm x 73.5 mm |
| Alternator Output | 1456W @ 5000 RPM |
| Compression Ratio | 10.8:1 |
| Starting System | Electric |
| Fuel System | Electronic Fuel Injection |
| Ignition Timing | ECU Controlled 32° +/- 2° @ 5000 RPM |
| Spark Plug/ Gap | MR7F / 0.7-0.8 mm |
| Lubrication System | Wet Sump |
| Cooling | Liquid |
| Front Suspension | Dual A-Arm 10.0 in (25.4 cm) Travel |
| Rear Suspension | Dual A-Arm 10.0 in (25.4 cm) Travel |
| Ignition System | Digital CDI |
| Driving System Type | Pro-PVT |
| Shift Type | Single Lever (H/L/N/R/P) |
| Gear Reduction - Low | Front 9.65:1 / Rear 28.84:1 |
| Gear Reduction - Reverse | Front 9.16:1 / Rear 27.39:1 |
| Gear Reduction - High | Front 4.35:1 / Rear 13.01:1 |
| Drive Ratio - Front | 3.23:1 |
| Tire Size - Front | 29 x 9-14; PRO ARMOR® X-TERRAIN |
| Tire Size - Rear | 29 x 11-14; PRO ARMOR® X-TERRAIN |

SPECIFICATIONS

| DESCRIPTION | SPECIFICATION |
|-----------------------|--|
| Tire Pressure - Front | 10 psi (69 kPa) CREW: 23 psi (159 kPa) |
| Tire Pressure - Rear | 14 psi (97 kPa) CREW: 25 psi (172 kPa) |
| Brakes, Front/Rear | Foot Activated, 4 wheel hydraulic disc with dual-bore front calipers |
| Hood Headlights | LED - replace entire assembly if fault occurs |
| Taillights | LED |
| Brake Light | LED |

**Dry weight is also listed on the Certificate of Origin for your vehicle in the Shipping Weight field. The dry weight is estimated based on the manufactured weight of the vehicle minus any serviceable fluids and may also exclude the weight of factory installed accessories not essential to the vehicle's basic operation as outlined in the ANSI®/ROHVA® 1-2016 standard.*

SPECIFICATIONS

RANGER / CREW XP 1000 NORTHSTAR EDITION TRAIL BOSS

| DESCRIPTION | SPECIFICATION |
|--|---|
| Maximum Weight Capacity (includes weight of operator, passenger, cargo, accessories) | 1275 lb (578 kg) CA Models: 1100 lb (499 kg) CREW: 1150 lb (522 kg) |
| Dry Weight* | 1966 lb (892 kg) CREW: 2398 lb (1088 kg) |
| Test GVW - Rollover Protection System (ROPS) | 3600 lb (1633 kg) per OSHA® 29 CFR 1928.53 CREW: 3750 lb (1701 kg) per OSHA® 29 CFR 1928.53 |
| Fuel Capacity | 11.5 gal (43.5 L) |
| Engine Oil Capacity | 2.5 qt (2.4 L) |
| Coolant Capacity | 5.5 qt (5.2 L) CREW: 6.25 qt (5.9 L) |
| Overall Length | 120 in (305 cm) CREW: 152 in (386 cm) |
| Overall Width | 65 in (165 cm) |
| Overall Height | 79.5 in (198 cm) |
| Wheelbase | 81 in (206 cm) CREW: 113 in (287 cm) |
| Cargo Box Dimensions (Inside) | 36.75 x 54.25 x 12.5 in (93 x 138 x 32 cm) |
| Ground Clearance | 14 in (36 cm) |
| Min. Turning Radius | 156 in (396 cm) |
| Towing Capacity | 2500 lb (1133 kg) |
| Hitch Tongue Capacity | 250 lb (113 kg) |
| Max. Cargo Box Load | 1000 lb (454 kg) CA Model: 600 lb (272 kg) |

SPECIFICATIONS

| DESCRIPTION | SPECIFICATION |
|--------------------------|--|
| Engine | 4-Stroke DOHC Twin Cylinder |
| Displacement | 999 cc |
| Bore x Stroke (mm) | 93 mm x 73.6 mm |
| Alternator Output | 1456W @ 5000 RPM |
| Compression Ratio | 10.8:1 |
| Starting System | Electric |
| Fuel System | Electronic Fuel Injection |
| Ignition Timing | ECU Controlled 32° +/- 2° @ 5000 RPM |
| Spark Plug/ Gap | MR7F / 0.7-0.8 mm |
| Lubrication System | Wet Sump |
| Cooling | Liquid |
| Front Suspension | Independent, Arched Lower A-arms, 10.0 in. (25.4 cm) Travel |
| Rear Suspension | Independent, Arched Lower A-arms, Nivomat Load-Adaptive, 10.0 in. (25.4 cm) Travel |
| Ignition System | Digital CDI |
| Driving System Type | Pro-PVT |
| Shift Type | Single Lever (H/L/N/R/P) |
| Gear Reduction - Low | Front 9.65:1 / Rear 28.84:1 |
| Gear Reduction - Reverse | Front 9.16:1 / Rear 27.39:1 |
| Gear Reduction - High | Front 4.35:1 / Rear 13.01:1 |
| Drive Ratio - Front | 3.23:1 |
| Tire Size - Front | 29 x 9-14; PRO ARMOR® X-TERRAIN |

SPECIFICATIONS

| DESCRIPTION | SPECIFICATION |
|-----------------------|--|
| Tire Size - Rear | 29 x 11-14; PRO ARMOR® X-TERRAIN |
| Tire Pressure - Front | 10 psi (69 kPa) CREW: 23 psi (159 kPa) |
| Tire Pressure - Rear | 14 psi (97 kPa) CREW: 25 psi (172 kPa) |
| Brakes, Front/Rear | Foot Activated, 4 wheel hydraulic disc with dual-bore front calipers |
| Hood Headlights | LED - replace entire assembly if fault occurs |
| Taillights | LED |
| Brake Light | LED |

**Dry weight is also listed on the Certificate of Origin for your vehicle in the Shipping Weight field. The dry weight is estimated based on the manufactured weight of the vehicle minus any serviceable fluids and may also exclude the weight of factory installed accessories not essential to the vehicle's basic operation as outlined in the ANSI®/ROHVA® 1-2016 standard.*

RANGER CREW XP 1000 TEXAS EDITION

| DESCRIPTION | SPECIFICATION |
|--|--|
| Maximum Weight Capacity (includes weight of operator, passenger, cargo, accessories) | 1600 lb (726 kg) |
| Dry Weight* | 1953 lb (886 kg) |
| Test GVW - Rollover Protection System (ROPS) | 3750 lb (1701 kg) per OSHA® 29 CFR 1928.53 |
| Fuel Capacity | 11.5 gal (43.5 L) |
| Engine Oil Capacity | 2.5 qt (2.4 L) |
| Coolant Capacity | 5 qt (4.75 L) CREW: 5.65 qt (5.35 L) |
| Overall Length | 152 in (386 cm) |

SPECIFICATIONS

| DESCRIPTION | SPECIFICATION |
|-------------------------------|--|
| Overall Width | 62.5 in (158 cm) |
| Overall Height | 79.5 in (198 cm) |
| Wheelbase | 113 in (287 cm) |
| Cargo Box Dimensions (Inside) | 36.75 x 54.25 x 12.5 in (93 x 138 x 32 cm) |
| Ground Clearance | 14 in (35.5 cm) |
| Min. Turning Radius | 156 in (396 cm) |
| Towing Capacity | 2500 lb (1136 kg) |
| Hitch Tongue Capacity | 250 lb (113 kg) |
| Max. Cargo Box Load | 1000 lb (454 kg) |
| Engine | 4-Stroke DOHC Twin Cylinder |
| Displacement | 999 cc |
| Bore x Stroke (mm) | 93 mm x 64.4 mm |
| Stator Output | 660 W @ 3000 RPM |
| Compression Ratio | 10.8:1 |
| Starting System | Electric |
| Fuel System | Electronic Fuel Injection |
| Ignition Timing | ECU Controlled 32° +/- 2° @ 5000 RPM |
| Spark Plug/ Gap | MR7F / 0.7-0.8 mm |
| Lubrication System | Wet Sump |
| Cooling | Liquid |
| Front Suspension | Independent, Arched Lower A-arms, 10 in. (25.4 cm) of Travel |
| Rear Suspension | Independent, Arched Lower A-arms, 10 in. (25.4 cm) of Travel |

SPECIFICATIONS

| DESCRIPTION | SPECIFICATION |
|--------------------------|--|
| Ignition System | Digital CDI |
| Driving System Type | Pro-PVT |
| Shift Type | Single Lever (H/L/N/R/P) |
| Gear Reduction - Low | Front 9.65:1/ Rear 28.84:1 |
| Gear Reduction - Reverse | Front 9.16:1 / Rear 27.39:1 |
| Gear Reduction - High | Front 4.35:1 / Rear 13.01:1 |
| Drive Ratio - Front | 3.23:1 |
| Tire Size - Front | 29 x 9-14; PRO ARMOR® X-TERRAIN |
| Tire Size - Rear | 29 x 11-14; PRO ARMOR® X-TERRAIN |
| Tire Pressure - Front | 14 psi (97 kPa) |
| Tire Pressure - Rear | 16 psi (110 kPa) |
| Brakes, Front/Rear | Foot Activated, 4 wheel hydraulic disc with dual-bore front calipers |
| Hood Headlights | LED - replace entire assembly if fault occurs |
| Taillights | 10 LED (.28 W) |
| Brake Light | 10 LED (3.1 W) |

**Dry weight is also listed on the Certificate of Origin for your vehicle in the Shipping Weight field. The dry weight is estimated based on the manufactured weight of the vehicle minus any serviceable fluids and may also exclude the weight of factory installed accessories not essential to the vehicle's basic operation as outlined in the ANSI®/ROHVA® 1-2016 standard.*

POLARIS PRODUCTS

LUBRICANTS / SERVICE PRODUCTS

| PRODUCT | SIZE (QUANTITY) | QUANTITY | PART NUMBER |
|---------------------------------------|--------------------------------|----------|-------------|
| Fogging Oil | 12 fl oz (355 mL) aerosol | 12 | 2870791 |
| | 1 qt (0.95 L) | 12 | 2871517 |
| PS-4 | 1 qt (0.95 L) | 12 | 2876244 |
| | 2 qt (1.90 L) | 8 | 2877490 |
| | 1 gal (3.8 L) | 4 | 2876245 |
| PS-4 Extreme Duty | 1 qt (0.95 L) | 12 | 2878920 |
| | 2 qt (1.90 L) | 8 | 2878922 |
| | 1 gal (3.8 L) | 4 | 2878919 |
| | 1 qt (0.95 L) | 12 | 2889395 |
| | 1 gal (3.8 L) | 4 | 2889396 |
| AGL | 1 qt (0.95 L) | 12 | 2878068 |
| | 1 gal (3.8 L) | 4 | 2878069 |
| Pump for Gallon Jug | — | 1 | 2870465 |
| Demand Drive | 1 qt (0.95 L) | 12 | 2877922 |
| | 2.5 gal (9.5 L) | 2 | 2877923 |
| Antifreeze / Coolant | 1 qt (0.95 L) | 12 | 2880514 |
| | 1 gal (3.8 L) | 6 | 2880513 |
| Grease Gun Kit, Premium All Season | — | 1 | 2871312 |
| All Season Grease | Four 3 fl oz (89 mL) packs | 6 | 2871322 |
| | 14 fl oz (414 mL) cartridge | 1 | 2871423 |
| Premium Starter Grease | — | 1 | 2871460 |
| U-Joint Grease | 3 fl oz (89 mL) tube | 24 | 2871515 |
| | 14 fl oz (414 mL) cartridge | 1 | 2871551 |
| Dielectric Grease (Nyogel®) | — | 1 | 2871329 |

POLARIS PRODUCTS

| PRODUCT | SIZE (QUANTITY) | QUANTITY | PART NUMBER |
|---|--------------------------|----------|-------------|
| Carbon Clean | 12 fl oz (355 mL) bottle | 12 | 2871326 |
| Fuel Stabilizer | 16 fl oz (473 mL) | 12 | 2870652 |
| | 2.5 gal (9.5 L) | 2 | 2872280 |
| DOT 4 Brake Fluid | — | 1 | 2872189 |
| Loctite® 565 Thread Sealant | — | 1 | 2871956 |
| BatteryMINDER® 2012 AGM - 2 AMP Charger | — | 1 | 2830438 |

TROUBLESHOOTING

DRIVE BELT WEAR/BURN

| POSSIBLE CAUSE | SOLUTION |
|--|--|
| Driving onto a pickup or tall trailer in high range | Use low range during loading. |
| Starting out going up a steep incline | Use low range. |
| Driving at low RPM or ground speed – 3–7 mph (4.8–11.3 km/h) | Drive at a higher speed or use low range more frequently. |
| Insufficient warm-up at low ambient temperatures | Warm the engine at least 5 minutes. With the transmission in neutral, advance the throttle to about 1/8 throttle in short bursts, 5 to 7 times. The belt will become more flexible and prevent belt burning. |
| Slow/easy clutch engagement | Use the throttle quickly and effectively. |
| Towing/pushing at low RPM/low ground speed | Use low range only. |
| Utility use/plowing | Use low range only. |
| Stuck in mud or snow | Shift the transmission to low range and carefully use fast, aggressive throttle application to engage clutch. WARNING: Excessive throttle may cause loss of control and vehicle rollover. |
| Climbing over large objects from a stopped position | Shift the transmission to low range and carefully use fast, brief, aggressive throttle application to engage clutch. WARNING: Excessive throttle may cause loss of control and vehicle rollover. |
| Belt slippage from water or snow ingestion into the PVT system | Dry out the PVT. Prevent water from entering the PVT intake duct. See Intake Pre-Filters for more information. Inspect clutch seals for damage if repeated leaking occurs. |
| Clutch malfunction | An authorized dealer can assist. |
| Poor engine performance | Check for clogged air filter, clogged fuel filter, water in the fuel or foreign material in fuel tank or fuel lines. An authorized dealer can assist. |
| Slippage from failure to warm up belt | Always warm up the belt by operating below 30 mph (48 km/h) for 1 miles (1.6 km) (5 miles (8 km) or more when temperature is below freezing). |
| Wrong or missing belt | Install the recommended belt. |
| Improper break-in | Always break in a new belt and/or clutch. |

TROUBLESHOOTING

ENGINE DOESN'T TURN OVER

| POSSIBLE CAUSE | SOLUTION |
|--|---------------------------------------|
| Low battery voltage | Recharge the battery. |
| Loose battery connections | Check all connections and tighten. |
| Loose solenoid connections | Check all connections and tighten. |
| Loose electronic control box connections | Inspect, clean, reinstall connectors. |

ENGINE TURNS OVER, FAILS TO START

| POSSIBLE CAUSE | SOLUTION |
|--------------------------------|--|
| Out of fuel | Refuel. |
| Water is present in fuel | Drain the fuel system and refuel. |
| Old or non-recommended fuel | Replace with fresh recommended fuel. |
| Fouled or defective spark plug | Inspect plug and replace if necessary. |
| No spark to spark plug | Inspect plug and replace if necessary. |
| Water or fuel in crankcase | Your authorized dealer can assist. |
| Low battery voltage | Recharge the battery to 12.8 VDC. |
| Mechanical failure | Your authorized dealer can assist. |

ENGINE BACKFIRES

| POSSIBLE CAUSE | SOLUTION |
|--|--|
| Weak spark from spark plug | Inspect, clean and/or replace spark plug |
| Incorrect spark plug gap or heat range | Set gap to specs or replace plug |
| Old or non-recommended fuel | Replace with fresh recommended fuel |
| Incorrectly installed spark plug wires | Your authorized dealer can assist |

| POSSIBLE CAUSE | SOLUTION |
|----------------------------|-------------------------------------|
| Mechanical failure | Your authorized dealer can assist |
| Loose ignition connections | Check all connections and tighten |
| Water present in fuel | Replace with fresh recommended fuel |

ENGINE PINGS OR KNOCKS

| POSSIBLE CAUSE | SOLUTION |
|--|----------------------------------|
| Poor quality or low octane fuel | Replace with recommended fuel |
| Incorrect spark plug gap or heat range | Set gap to specs or replace plug |

ENGINE RUNS IRREGULARLY, STALLS OR MISFIRES

| POSSIBLE CAUSE | SOLUTION |
|--|---|
| Fouled or defective spark plug | Inspect, clean and/or replace spark plug |
| Worn or defective spark plug wires | Your authorized dealer can assist |
| Incorrect spark plug gap or heat range | Set gap to specs or replace plug |
| Loose ignition connections | Check all connections and tighten |
| Water present in fuel | Replace with new fuel |
| Low battery voltage | Recharge battery to 12.8 VDC |
| Incorrect fuel | Replace with recommended fuel |
| Clogged air filter | Inspect and clean or replace |
| Clogged intake pre-filter | Inspect and clean (with soapy water) or replace |
| Other mechanical failure | Your authorized dealer can assist |

ENGINE STOPS OR LOSES POWER

| POSSIBLE CAUSE | SOLUTION |
|----------------------------------|-----------------------|
| Out of fuel | Refuel |
| Kinked or plugged fuel vent line | Inspect and replace |
| Water is present in fuel | Replace with new fuel |

TROUBLESHOOTING

| POSSIBLE CAUSE | SOLUTION |
|--|---|
| Fouled or defective spark plug | Inspect, clean and/or replace spark plug |
| Worn or defective spark plug wires | Your authorized dealer can assist |
| Incorrect spark plug gap or heat range | Set gap to specs or replace plug |
| Loose ignition connections | Check all connections and tighten |
| Low battery voltage | Recharge the battery |
| Incorrect fuel | Replace with fresh recommended fuel |
| Clogged air filter | Inspect and clean or replace |
| Clogged intake pre-filter | Inspect and clean (with soapy water) or replace |
| Other mechanical failure | Your authorized dealer can assist |
| Overheated engine | Clean radiator screen and core, clean engine exterior, and check coolant level. Your dealer can assist. |

WARRANTY

LIMITED WARRANTY

POLARIS Inc., 2100 Highway 55, Medina, MN 55340 (POLARIS) gives a ONE YEAR LIMITED WARRANTY on all components of your POLARIS vehicle against defects in material or workmanship. Laws and regulations in your jurisdiction may give extra protection. POLARIS further warrants that the spark arrester in this product will meet the efficiency requirements of USFS standard 5100-1C for at least 1000 hours when subjected to normal use and when maintenance and installation are in accordance with POLARIS recommendations.

This warranty covers parts and labor charges for repair or replacement of defective parts and begins on the date of purchase by the original retail purchaser. This warranty is transferable to another owner during the warranty period through a POLARIS dealer, but any such transfer will not extend the original term of the warranty. The duration of this warranty may vary by international region based upon local laws and regulations.

REGISTRATION

At the time of sale, the Warranty Registration Form must be completed by your dealer and submitted to POLARIS within ten days of purchase. Upon receipt of this registration, POLARIS will record the registration for warranty. No verification of registration will be sent to the purchaser as the copy of the Warranty Registration Form will be your proof of warranty coverage. If you have not signed the original registration and received the customer copy, please contact your dealer immediately. **NO WARRANTY COVERAGE WILL BE ALLOWED UNLESS YOUR VEHICLE IS REGISTERED WITH POLARIS.** Initial dealer preparation and set-up of your vehicle is very important in ensuring trouble-free operation. Purchasing a machine in the crate or without proper dealer set-up will void your warranty coverage.

WARRANTY COVERAGE AND EXCLUSIONS

LIMITATIONS OF WARRANTIES AND REMEDIES

This POLARIS limited warranty excludes any failures that are not caused by a defect in material or workmanship. THIS WARRANTY DOES NOT COVER CLAIMS OF DEFECTIVE DESIGN. This warranty also does not cover acts of God, accidental damage, normal wear and tear, abuse or improper handling. This warranty also does not cover any vehicle, component, or part that has been altered structurally, modified, neglected, improperly maintained or used for racing, competition or purposes other than for which it was designed.

This warranty excludes damages or failures resulting from improper lubrication; improper engine timing; improper fuel; surface imperfections caused by external stress, heat, cold or contamination; operator error or abuse; improper component alignment, tension, adjustment or altitude compensation; snow, water, dirt or other foreign substance ingestion/contamination; improper maintenance; modified components; use of aftermarket or unapproved components, accessories, or attachments; use of unapproved software or calibration; unauthorized repairs; or repairs made after the warranty period expires or by an unauthorized repair center.

This warranty excludes damages or failures caused by abuse, accident, fire, or any other cause other than a defect in materials or workmanship and provides no coverage for consumable components, general wear items, or any parts exposed to friction surfaces, stresses, environmental conditions and/or contamination for which they were not designed or not intended, including but not limited to the following items:

- Wheels and tires
- Suspension components
- Brake components
- Seat components
- Clutches and components
- Steering components
- Batteries
- Light bulbs/Sealed beam lamps
- Filters
- Lubricants
- Bushings
- Finished and unfinished surfaces
- Carburetor/Throttle body components
- Engine components
- Drive belts
- Hydraulic components and fluids
- Circuit breakers/Fuses
- Electronic components
- Spark plugs
- Sealants
- Coolants
- Bearings

LUBRICANTS AND FLUIDS

1. Mixing oil brands or using non-recommended oil may cause engine damage. We recommend the use of POLARIS engine oil.
2. Damage or failure resulting from the use of non-recommended lubricants or fluids is not covered by this warranty.

This warranty provides no coverage for personal loss or expense, including mileage, transportation costs, hotels, meals, shipping or handling fees, product pick-up or delivery, replacement rentals, loss of product use, loss of profits, or loss of vacation or personal time.

THE EXCLUSIVE REMEDY FOR BREACH OF THIS WARRANTY SHALL BE, AT POLARIS' OPTION, REPAIR OR REPLACEMENT OF ANY DEFECTIVE MATERIALS, COMPONENTS, OR PRODUCTS. THE REMEDIES SET FORTH IN THIS WARRANTY ARE THE ONLY REMEDIES AVAILABLE TO ANY PERSON FOR BREACH OF THIS WARRANTY. POLARIS SHALL HAVE NO LIABILITY TO ANY PERSON FOR INCIDENTAL, CONSEQUENTIAL OR SPECIAL DAMAGES OF ANY DESCRIPTION, WHETHER ARISING OUT OF EXPRESS OR IMPLIED WARRANTY OR ANY OTHER CONTRACT, NEGLIGENCE, OR OTHER TORT OR OTHERWISE. THIS EXCLUSION OF CONSEQUENTIAL, INCIDENTAL, AND SPECIAL DAMAGES IS INDEPENDENT FROM AND SHALL SURVIVE ANY FINDING THAT THE EXCLUSIVE REMEDY FAILED OF ITS ESSENTIAL PURPOSE.

THE IMPLIED WARRANTY OF FITNESS FOR A PARTICULAR PURPOSE IS EXCLUDED FROM THIS LIMITED WARRANTY. ALL OTHER IMPLIED WARRANTIES (INCLUDING BUT NOT LIMITED TO THE IMPLIED WARRANTY OF MERCHANTABILITY) ARE LIMITED IN DURATION TO THE ABOVE ONE YEAR WARRANTY PERIOD. POLARIS DISCLAIMS ALL EXPRESS WARRANTIES NOT STATED IN THIS WARRANTY. SOME STATES DO NOT PERMIT THE EXCLUSION OR LIMITATION OF INCIDENTAL OR CONSEQUENTIAL DAMAGES OR ALLOW LIMITATIONS ON THE DURATION OF IMPLIED WARRANTIES, SO THE ABOVE LIMITATIONS MAY NOT APPLY TO YOU IF INCONSISTENT WITH CONTROLLING STATE LAW.

WARRANTY

HOW TO OBTAIN WARRANTY SERVICE

If your vehicle requires warranty service, you must take it to a POLARIS Servicing Dealer. When requesting warranty service you must present your copy of the Warranty Registration Form to the dealer. (THE COST OF TRANSPORTATION TO AND FROM THE DEALER IS YOUR RESPONSIBILITY.) POLARIS suggests that you use your original selling dealer; however, you may use any POLARIS Servicing Dealer to perform warranty service.

IN THE COUNTRY WHERE YOUR PRODUCT WAS PURCHASED:

Warranty or Service Bulletin repairs must be done by an authorized POLARIS dealer, or other qualified person. If you move or are traveling within the country where your product was purchased, Warranty and Service Bulletin repairs may be requested from any authorized POLARIS dealer, or other qualified person, that sells the same line as your product.

OUTSIDE THE COUNTRY WHERE YOUR PRODUCT WAS PURCHASED:

If you are traveling temporarily outside the country where your product was purchased, you should take your product to an authorized POLARIS dealer, or other qualified person. You must show the dealer photo identification from the country of the selling dealer's authorized location as proof of residence. Upon residence verification, the servicing dealer will be authorized to perform the warranty repair.

IF YOU MOVE:

If you move to another country, be sure to contact POLARIS Customer Assistance and the customs department of the destination country before you move. Product importation rules vary considerably from country to country. You may be required to present documentation of your move to POLARIS in order to continue your warranty coverage. You may also be required to obtain documentation from POLARIS in order to register your product in your new country. You should warranty register your product at a local POLARIS dealer in your new country immediately after you move to continue your warranty coverage and to ensure that you receive information and notices regarding your product.

IF YOU PURCHASE FROM A PRIVATE PARTY:

If you purchase a POLARIS product from a private party, to be kept and used outside of the country in which the product was originally purchased, all warranty coverage will be denied. You must nonetheless register your product under your name and address with a local POLARIS dealer in your country to ensure that you receive safety information and notices regarding your product.

EXPORTED PRODUCTS

EXCEPT WHERE SPECIFICALLY REQUIRED BY LAW, THERE IS NO WARRANTY OR SERVICE BULLETIN COVERAGE ON THIS PRODUCT IF IT IS SOLD OUTSIDE THE COUNTRY OF THE SELLING DEALER'S AUTHORIZED LOCATION. This policy does not apply to products that have received authorization for export from POLARIS. Dealers may not give authorization for export. You should consult an authorized dealer to determine this product's warranty or service coverage if you have any questions. This policy does not apply to products registered to government officials or military personnel on assignment outside the country of the selling dealer's authorized location. This policy does not apply to Safety Bulletins.

NOTICE

If your product is registered outside of the country where it was purchased and you have not followed the procedure set above, your product will no longer be eligible for warranty or service bulletin coverage of any kind, other than safety recalls. Products registered to government officials or military personnel on assignment outside of the country where the product was purchased will continue to be covered by the Limited Warranty.

Please work with your dealer to resolve any warranty issues. Dealership contacts can be found via this website, if needed:

www.polaris.com/en-us/contact

Should your dealer require any additional assistance, they will contact the appropriate person at POLARIS.

This warranty gives you specific legal rights, and you may also have other rights which vary from state to state or in different countries. If any of the above terms are void because of federal, state, local law, all other warranty terms will remain in effect.

For questions call POLARIS Owner Connections:

United States & Canada: 1-800-POLARIS (1-800-765-2747)

French: 1-800-268-6334

To report a safety defect to Transport Canada, you may either fill out an online defect complaint form at their website:

English: <http://www.tc.gc.ca/recalls>

French: <http://www.tc.gc.ca/rappels>

Or contact their Defect Investigations and Recalls Division by calling toll-free 1-800-333-0510 (Canada) or 819-994-3328 (Ottawa-Gatineau area / International).

U.S.A. EPA EMISSIONS LIMITED WARRANTY

This emissions limited warranty is in addition to the POLARIS standard limited warranty for your vehicle. Polaris Industries Inc. warrants that at the time it is first purchased, this emissions-certified vehicle is designed, built and equipped so it conforms with applicable U.S. Environmental Protection Agency emission regulations. POLARIS warrants that the vehicle is free from defects in materials and workmanship that would cause it to fail to meet these regulations.

The warranty period for off road vehicles 100 cm³ or greater emissions-certified vehicles starts on the date of purchase by original retail purchaser and continues for a period of 500 hours of engine operation, 3100 miles (5000 km) of vehicle travel, or 30 calendar months from the date of purchase, whichever comes first. The warranty period for ATVs less than 100 cm³ emissions-certified vehicles starts on the date of purchase by original retail purchaser and continues for a period of 250 hours of engine operation, 1550 miles (2500 km) of vehicle travel, or 30 calendar months from the date of purchase, whichever comes first. This EPA emissions warranty period is extended for at least as long as the standard factory warranty that Polaris provides on the vehicle as a whole. The EPA emissions warranty period does not further extend if you purchase additional warranty coverage in the form of a service contract or other paid warranty extension, but emission-related parts may be covered subject to the terms of any such paid service contract or paid warranty extension.

This emissions limited warranty covers components whose failure increases the vehicle's regulated emissions, and it covers components of systems whose only purpose is to control emissions. Repairing or replacing other components not covered by this warranty is the responsibility of the vehicle owner. This emissions limited warranty does not cover components whose failure does not increase the vehicle's regulated emissions.

For exhaust emissions, emission-related components include any engine parts related to the following systems:

- Air-induction system
- Fuel system
- Ignition system
- Exhaust gas recirculation systems

The following parts are also considered emission-related components for exhaust emissions:

- Aftertreatment devices
- Crankcase ventilation valves
- Sensors
- Electronic control units

The following parts are considered emission-related components for evaporative emissions:

- Fuel Tank
- Fuel Cap
- Fuel Line
- Fuel Line Fittings
- Clamps*
- Pressure Relief Valves*
- Control Valves*
- Control Solenoids*
- Electronic Controls*
- Vacuum Control Diaphragms*
- Control Cables*
- Control Linkages*
- Purge Valves
- Vapor Hoses
- Liquid/Vapor Separator
- Carbon Canister
- Canister Mounting Brackets
- Carburetor Purge Port Connector

*As related to the evaporative emission control system.

Emission-related components also include any other part whose only purpose is to reduce emissions or whose failure will increase emissions without significantly degrading engine/equipment performance. The exclusive remedy for breach of this limited warranty shall be, at the exclusive option of POLARIS, repair or replacement of any defective materials, components or products. THE REMEDIES SET FORTH IN THIS LIMITED WARRANTY ARE THE ONLY REMEDIES AVAILABLE TO ANY PERSON FOR BREACH OF THIS WARRANTY. POLARIS SHALL HAVE NO LIABILITY TO ANY PERSON FOR INCIDENTAL, CONSEQUENTIAL OR SPECIAL DAMAGES OF ANY DESCRIPTION, WHETHER ARISING OUT OF EXPRESS OR IMPLIED WARRANTY OR ANY OTHER CONTRACT, NEGLIGENCE OR OTHER TORT OR OTHERWISE. THIS EXCLUSION OF CONSEQUENTIAL, INCIDENTAL, AND SPECIAL DAMAGES IS INDEPENDENT FROM AND SHALL SURVIVE ANY FINDING THAT THE EXCLUSIVE REMEDY FAILED OF ITS ESSENTIAL PURPOSE.

ALL IMPLIED WARRANTIES (INCLUDING BUT NOT LIMITED TO ANY IMPLIED WARRANTIES OF MERCHANTABILITY AND FITNESS FOR A PARTICULAR PURPOSE) ARE LIMITED IN DURATION TO THE WARRANTY PERIOD DESCRIBED HEREIN. POLARIS DISCLAIMS ALL EXPRESS WARRANTIES NOT STATED IN THIS WARRANTY. Some states do not allow limitations on how long an implied warranty lasts, so the above limitation may not apply if it is inconsistent with the controlling state law.

This limited warranty excludes failures not caused by a defect in material or workmanship. This limited warranty does not cover damage due to accidents, abuse or improper handling, maintenance or use. This limited warranty also does not cover any engine that has been structurally altered, or when the vehicle has been used in racing competition. This limited warranty also does not cover physical damage, corrosion or defects caused by fire, explosions or other similar causes beyond the control of POLARIS.

WARRANTY

Owners are responsible for performing the scheduled maintenance identified in the owner's manual. POLARIS may deny warranty claims for failures that have been caused by the owner's or operator's improper maintenance or use, by accidents for which POLARIS has no responsibility, or by acts of God.

Any qualified repair shop or person may maintain, replace, or repair the emission control devices or systems on your vehicle. An authorized POLARIS dealer, or other qualified person, can perform any service that may be necessary for your vehicle. POLARIS also recommends POLARIS parts, however equivalent parts may be used for such service. It is a potential violation of the Clean Air Act if a part supplied by an aftermarket parts manufacturer reduces the effectiveness of the vehicle's emission controls. Tampering with emission controls is prohibited by federal law.

CALIFORNIA RESIDENTS

Certain POLARIS Off-Road Vehicles are available in 49-state and 50-state versions. Only the 50-state models are certified for sale in California. The 50-state models available for sale in California are identified by the letter "B" in the ninth position of the model number (e.g., R16RTE87B). The POLARIS 50-state models are designed and built with features such as a reduced cargo box capacity. Any modifications to these features may be a violation of the applicable California regulations and may void this limited emissions warranty offered by the manufacturer.

POLARIS Inc. warrants that at the time is first purchased, this vehicle is:

1. Designed, built, and equipped so as to conform, at the time of sale, with all applicable California evaporative emissions regulations.
2. Free from defects in material and workmanship that may cause the failure of a warranted part as defined in California evaporative emissions regulations. All replacement parts must be identical in all material respects to that part as described in the OHRV manufacturer's Executive Order of Certification application.

The California evaporative emissions control system limited warranty statement below applies to your Off Highway Recreational Vehicle in California if the vehicle is equipped with an evaporative emission control system and is labeled with a Vehicle Evaporative Emissions Control Information label indicating that the vehicle conforms to California evaporative emissions regulations applicable to new off-road sport vehicles, all-terrain vehicles, or off-road utility vehicles. These vehicles are referred to as "OHRV-EVAP" below.

CALIFORNIA EMISSION CONTROL WARRANTY STATEMENT YOUR WARRANTY RIGHTS AND OBLIGATIONS

The California Air Resources Board and Polaris Industries Inc. are pleased to explain the emission control system warranty on your model year 2018 and newer Off Highway Recreational Vehicle. In California, new off-highway recreational vehicles must be designed, built and equipped to meet the State's stringent anti-smog standards. Polaris must warrant the emission control system on your OHRV-EVAP for the periods of time listed below provided there has been no abuse, neglect or improper maintenance of your OHRV-EVAP.

Your emission control system may include parts such as the carburetor or fuel injection system, fuel tank, fuel hoses, carbon canister, engine computer and Evaporative Emissions Control System parts listed in the U.S.A. EPA Emissions Limited Warranty. Also included may be hoses, belts, connectors and other emission-related assemblies. Where a warrantable condition exists, Polaris will repair your OHRV-EVAP at no cost to you including diagnosis, parts and labor.

MANUFACTURER'S WARRANTY COVERAGE:

For model year 2018 and newer OHRV-EVAP models.

For 30 months, or 2500 miles (4023 km), or 250 hours, whichever comes first, except for evaporative components over the OHRV high-priced warranty value, which is covered for 60 months, or 5000 miles (8047 km), or 500 hours, whichever comes first.

If any emission-related part on your OHRV-EVAP is defective, the part will be repaired or replaced by Polaris.

OWNER'S WARRANTY RESPONSIBILITIES:

As the OHRV-EVAP owner, you are responsible for the performance of the required maintenance listed in your owner's manual. Polaris recommends that you retain all receipts covering maintenance on your OHRV-EVAP, but Polaris cannot deny warranty solely for the lack of receipts or for your failure to ensure the performance of a scheduled maintenance.

As an owner you are responsible for presenting your OHRV-EVAP to a Polaris dealer as soon as a problem exists. The warranty repairs should be completed in a reasonable amount of time, not to exceed 30 days.

As an OHRV-EVAP owner, you should also be aware that Polaris may deny you warranty coverage if your OHRV-EVAP or a part has failed due to abuse, neglect, improper maintenance or unapproved modifications.

ADD-ON OR MODIFIED PARTS

An add-on or modified part must be compliant with applicable CARB emission control standards. A violation of this requirement is punishable by civil and/or criminal punishment.

If you have any questions regarding your warranty rights and responsibilities, you should contact Polaris Customer Assistance at 1-800-POLARIS (1-800-765-2747) or the California Air Resources Board at 9528 Telstar Avenue, El Monte, CA 91731.

WARRANTY

United States & Canada: 1-800-POLARIS (1-800-765-2747)

French: 1-800-268-6334

| | | |
|--|--|--|
| A | | Component Locations..... 45 |
| Active Descent Control Switch (if equipped)..... 51 | | Component Locations - CREW 46 |
| Active Descent Control System (if equipped)..... 51 | | Console..... 47 |
| Adding or Changing Coolant 112 | | Cooling System..... 112 |
| Air Box Caution 35 | | Crankcase Emission Control System 97 |
| Air Conditioning..... 114 | | |
| Air Filter / Air Box..... 143 | | |
| Air Intake Maintenance Air Filter Replacement 123 | | |
| All Wheel Drive/Rear Differential System 93 | | |
| Auxiliary Outlet..... 54 | | |
| Axle and Wheel Nut Torque Specifications..... 129 | | |
| B | | |
| Battery 138 | | |
| Battery Installation 141 | | |
| Battery Maintenance and Charging 139 | | |
| Battery Removal..... 140 | | |
| Battery Storage..... 141 | | |
| Battery Trickle-Charging Outlet..... 54 | | |
| Before You Ride 73 | | |
| Belt Inspection 119 | | |
| Belt Life 91 | | |
| Belt Removal..... 117 | | |
| Brake Lights 133 | | |
| Brake Pedal 55 | | |
| Brake System Break-in 84 | | |
| Brakes 124 | | |
| Braking 89 | | |
| Break-in Period 83 | | |
| C | | |
| California Residents 174 | | |
| Carbon Dioxide Emissions..... 149 | | |
| Check Engine Indicator 71 | | |
| Clean the Exterior..... 143 | | |
| Clutch Cover Warning..... 34 | | |
| Cold Weather Operation..... 88 | | |
| | | |
| | | D |
| | | Declaration of Conformity 11 |
| | | Demand Change Oil Change 110 |
| | | Demand Drive Oil Check 110 |
| | | Display Mode..... 78 |
| | | Display Units, Standard/Metric 69 |
| | | Drive Belt Installation 119 |
| | | Drive Belt Wear/Burn..... 163 |
| | | Dumping the Cargo Box..... 92 |
| | | |
| | | E |
| | | Electromagnetic Interference 97 |
| | | Electronic Power Steering 59 |
| | | Emissions Limited Warranty..... 172 |
| | | Engine and Drivetrain Break-in 83 |
| | | Engine Backfires 164 |
| | | Engine Doesn't Turn Over 164 |
| | | Engine Oil..... 103 |
| | | Engine Oil and Filter Replacement 105 |
| | | Engine Pings or Knocks 165 |
| | | Engine Runs Irregularly, Stalls or Misfires 165 |
| | | Engine Stopping..... 88 |
| | | Engine Stops or Loses Power 165 |
| | | Engine Turns Over, Fails to Start..... 164 |
| | | Error Codes, Engine..... 71 |
| | | European Vibration and Noise 10 |
| | | Exhaust Emission Control System 97 |
| | | Exported Products 171 |

| | |
|----------------------------|-----|
| F | |
| Fan, Cooling | 112 |
| Fluid Levels | 143 |
| Fluid Part Numbers | 161 |
| Fog the Engine | 144 |
| Fuel Cap | 59 |
| Fuel Recommendations | 88 |
| Fuel Stabilizer | 143 |
| Fuses | 135 |

| | |
|------------------------------------|-----|
| G | |
| Gear Selector | 49 |
| Gearcase Specification Chart | 108 |

| | |
|---------------------------------|-----|
| H | |
| Hauling Cargo | 90 |
| HD Model Safety Labels | 40 |
| Headlight Beam Adjustment | 133 |
| Headlights | |
| Bulb Replacement | 132 |
| Hitch Capacity Alert | 41 |
| Hood Latches | 60 |
| How To Obtain Warranty | |
| Service | 170 |
| HVAC Control Panel | 52 |

| | |
|-----------------------------|-----|
| I | |
| Ignition Switch | 48 |
| Inspect and Lubricate | 144 |
| Instrument Cluster | 61 |
| Indicator Lamps | 62 |

| | |
|-----------------------------|----|
| K | |
| Know Your Riding Area | 87 |

| | |
|------------------------------|----|
| L | |
| Labels | |
| Fuel Transport Warning | 34 |

| | |
|-------------------------------------|---------|
| Light Switch | 50 |
| Lights | 131-132 |
| Limited Warranty | 167 |
| Load Warning | 35, 42 |
| Lubricants / Service Products | 161 |
| Lubrication Recommendations ... | 101 |

| | |
|-----------------------|-----|
| M | |
| Maintenance Log | 177 |
| Metric Display | 69 |
| Mode Button | 62 |

| | |
|--------------------------------------|-----|
| N | |
| Near-field Communication (NFC) | 9 |
| Noise Emission Control System | 97 |
| Notice | 171 |

| | |
|-------------------------------------|-----|
| O | |
| Oil and Filter | 143 |
| Oil Check | 104 |
| Oil Recommendations | 104 |
| Operation on Public Lands in | |
| the U.S.A. | 97 |
| Overflow Bottle Coolant Level | 114 |

| | |
|-------------------------------------|--------|
| P | |
| Park Brake Lever | 56 |
| Parking the Vehicle | 89 |
| Part Numbers | 161 |
| Passenger Warning | 35, 42 |
| Payload Warning/Shift Caution | 33 |
| Plugs, Spark | 111 |
| Polaris 3-Mode Throttle Control | |
| Switch | 51 |
| Polaris Products | 161 |
| POLARIS Variable | |
| Transmission (PVT) Drying | 121 |
| POLARIS Variable | |
| Transmission System | 116 |
| Power Steering | 59 |

| | |
|------------------------------------|----|
| Pre-Ride Inspection | 84 |
| Programmable Service Interval..... | 70 |
| Proper Use Warning | 32 |
| PVT Break-in (Clutches/Belt) | 84 |

R

| | |
|--|-----|
| Radiator and Cooling Fan..... | 112 |
| Radiator Coolant Level | 113 |
| Radio Compliance Statements | 12 |
| Rear Window Panel | 60 |
| Registration, Warranty | 167 |
| Removal from Storage..... | 145 |
| Ride Command | |
| Buttons | 74 |
| Driveline Mode..... | 76 |
| Gauge Screens..... | 77 |
| Gauge View Mode | 78 |
| Icon Bar..... | 79 |
| Overview | 74 |
| Settings..... | 77 |
| Rider Information Center | 64 |
| Rollover Protective Structure (ROPS)..... | 59 |

S

| | |
|---|----|
| Safe Operation Practices | 86 |
| Safety | |
| Driver and Passenger | |
| Qualifications | 16 |
| Driving Guidelines | 23 |
| Owner Requirements | 15 |
| Prepare Vehicle for the Ride | 17 |
| Prepare Yourself, Passengers, and Cargo for the Ride | 21 |
| Safety Labels | |
| HD Models..... | 40 |
| Safety Labels and Locations | 30 |
| Clutch Cover Alert | 40 |
| Intake Alert..... | 41 |
| Load/Passenger/Tire Pressure Alert | 43 |
| Shift Alert (HD Models) | 40 |
| Safety Symbols..... | 8 |

| | |
|---|-----|
| Seat and Storage | |
| Compartments | 58 |
| Seat Belt..... | 57 |
| Seat Belt / Driver Warning | 31 |
| Signal Words | 8 |
| Spark Arrester | 124 |
| Spark Plug Gap/Torque..... | 111 |
| Spark Plug Inspection..... | 111 |
| Spark Plug Recommendations | 111 |
| Specifications - NorthStar | |
| Edition Premium | 150 |
| Specifications - NorthStar | |
| Ultimate Edition | 153 |
| Specifications - NorthStar | |
| Ultimate Trail Boss | 156 |
| Specifications - Premium / MD / HD | 147 |
| Specifications - Texas Edition..... | 158 |
| Stabilize the Fuel..... | 143 |
| Starting the Engine | 87 |
| Steering Wheel | 49 |
| Steering Wheel Inspection..... | 127 |
| Stopping the Engine..... | 88 |
| Storage | 143 |
| Storage Area | 144 |
| Suspension Adjustment | 127 |
| Switches | |
| Light Switch..... | 50 |
| Mode Button..... | 62 |

T

| | |
|-----------------------------------|--------|
| Tachometer | 61 |
| Throttle Pedal | 55 |
| Tire Pressure Warning | 35, 42 |
| Tire Tread Depth | 129 |
| Tires | 129 |
| Towing Loads | 91 |
| Trail Etiquette | 87 |
| Trailer Hitch Bracket..... | 60 |
| Transmission Oil Change | 109 |
| Transmission Oil Check | 108 |
| Transporting the Vehicle..... | 145 |
| Tread Lightly SM | 87 |

U

| | |
|-----------------------|----|
| Update Maps | 81 |
| Update Software | 80 |

V

| | |
|--------------------------------------|-----|
| Vehicle Identification Numbers | 14 |
| Vehicle Immersion | 122 |

W

| | |
|----------------------------------|-----|
| Warning Symbols | 8 |
| Warranty Coverage And Exclusions | |
| Lubricants and Fluids | 169 |
| Washing the Vehicle | 142 |
| Welcome Page | 3 |
| Wet Fouled Plug | 112 |
| Wheel Installation | 130 |
| Wheel Removal | 130 |
| Winch Switch (if equipped) | 53 |
| Windshield Wiper/Washer | |
| Switch (if equipped) | 52 |



For your nearest Polaris dealer,
call 1-800-POLARIS (765-2747)
or visit www.polaris.com

Polaris Industries Inc.
2100 Highway 55
Medina, MN 55340

Polaris Sales Europe Sarl
Place de l'Industrie 2
1180 Rolle, Switzerland



Part No. 9941181 Rev 01
Printed in USA